

① ķērt sātna

pūdotrys

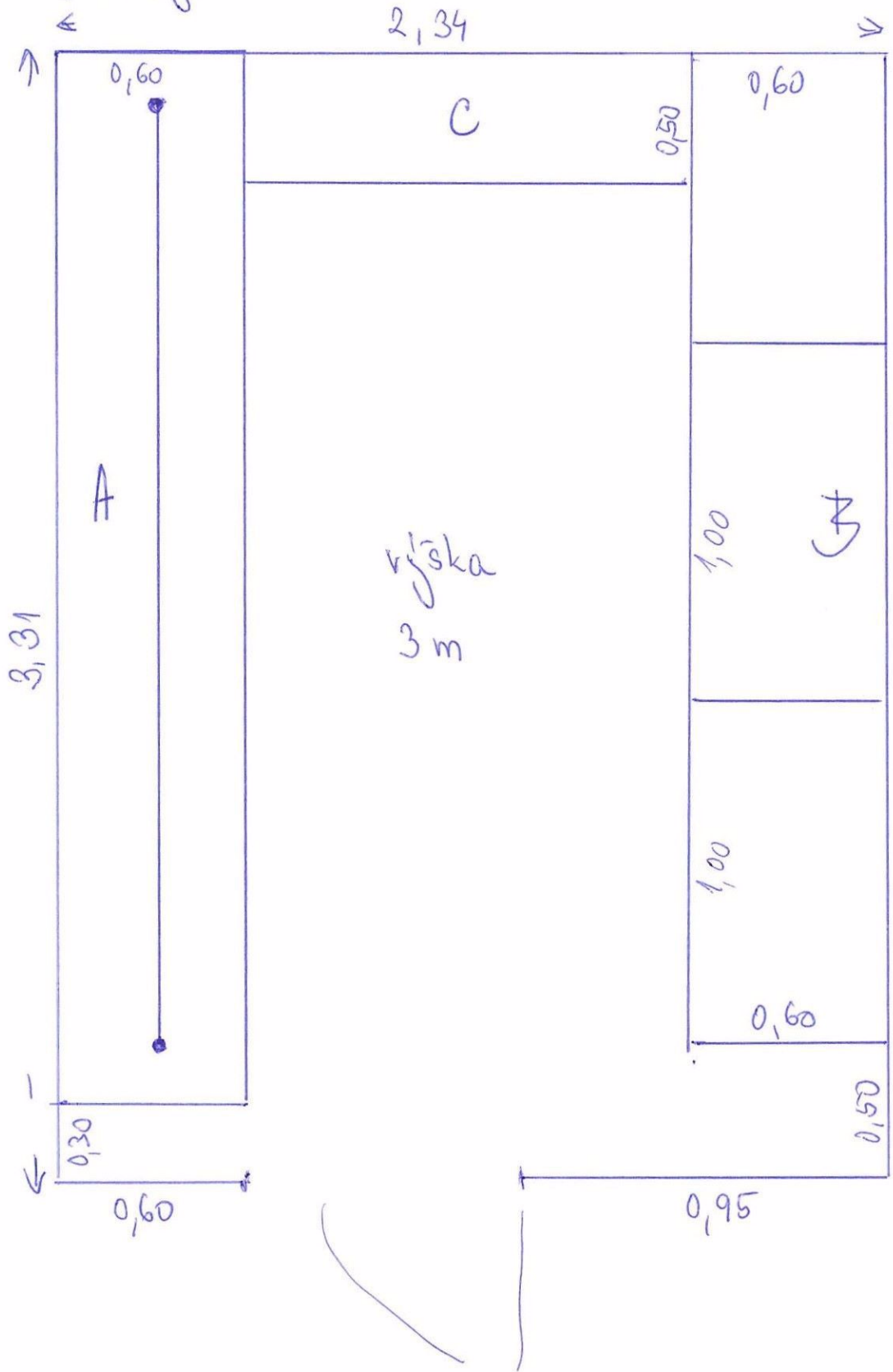

① 2. east

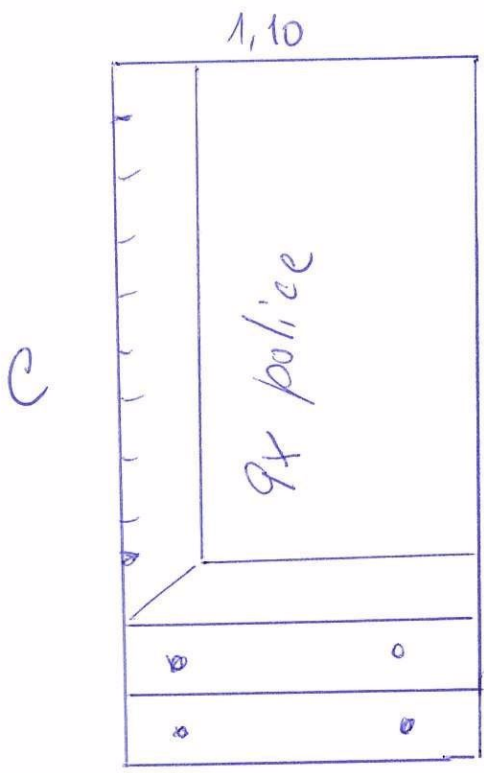
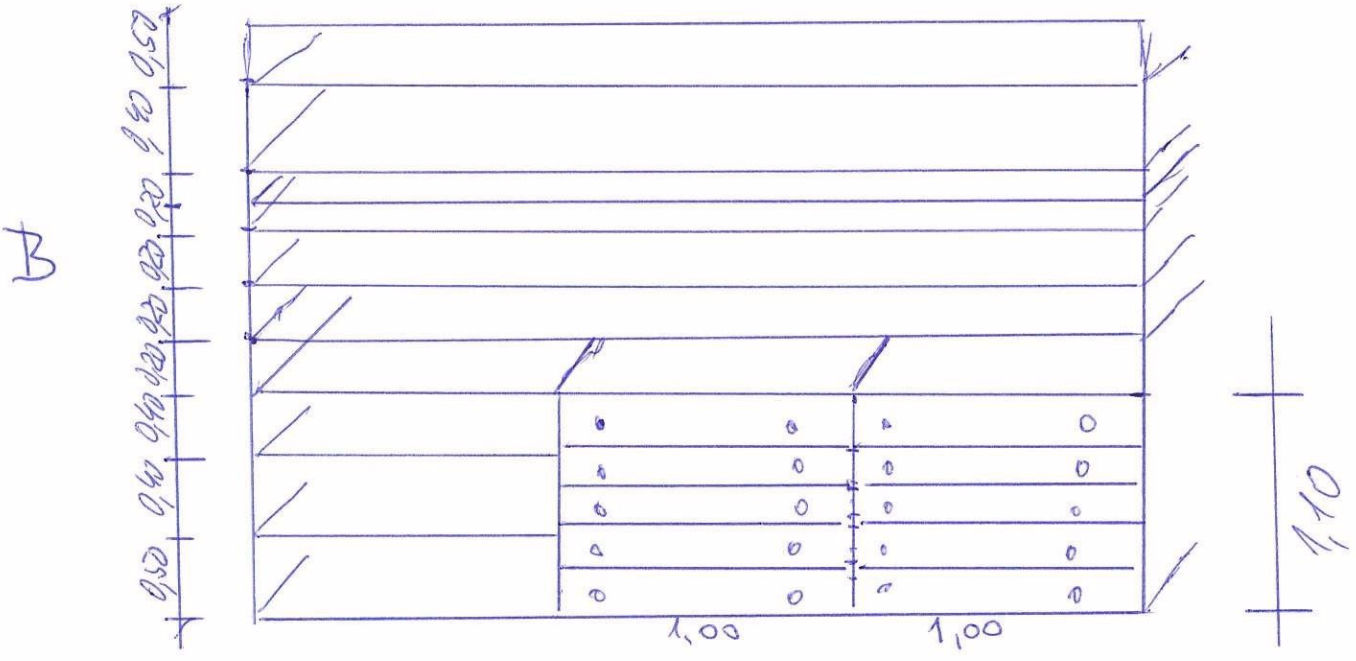
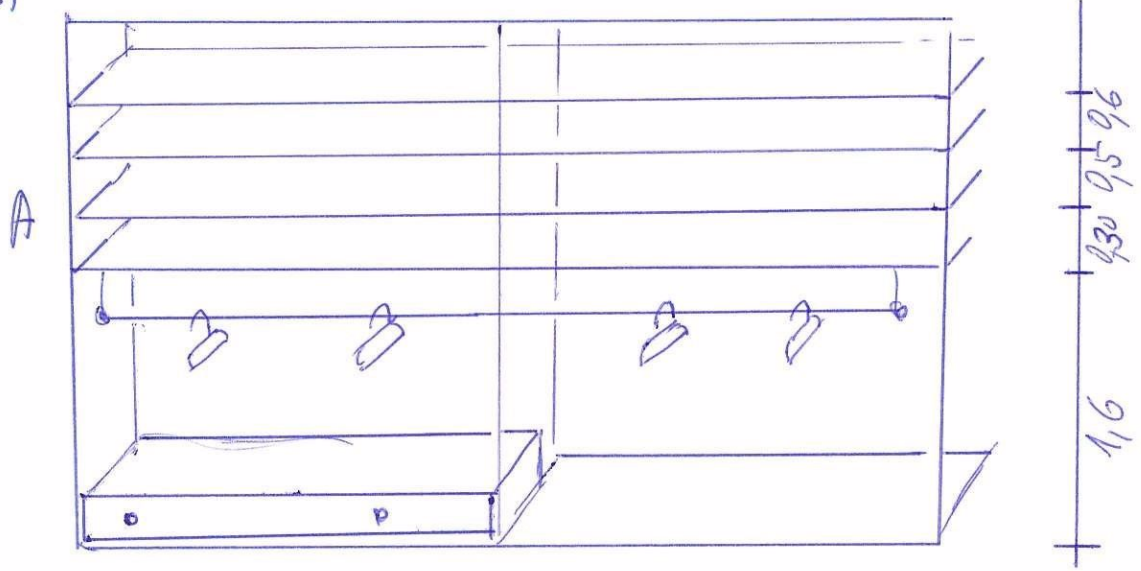

② Šatna + botník + laminátová stěna se sklopnými dveřmi (harmonika)

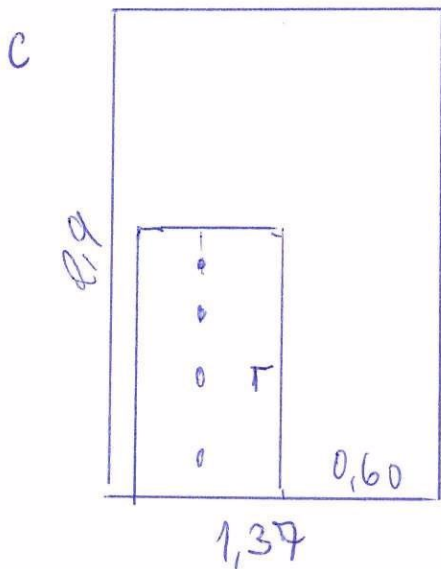
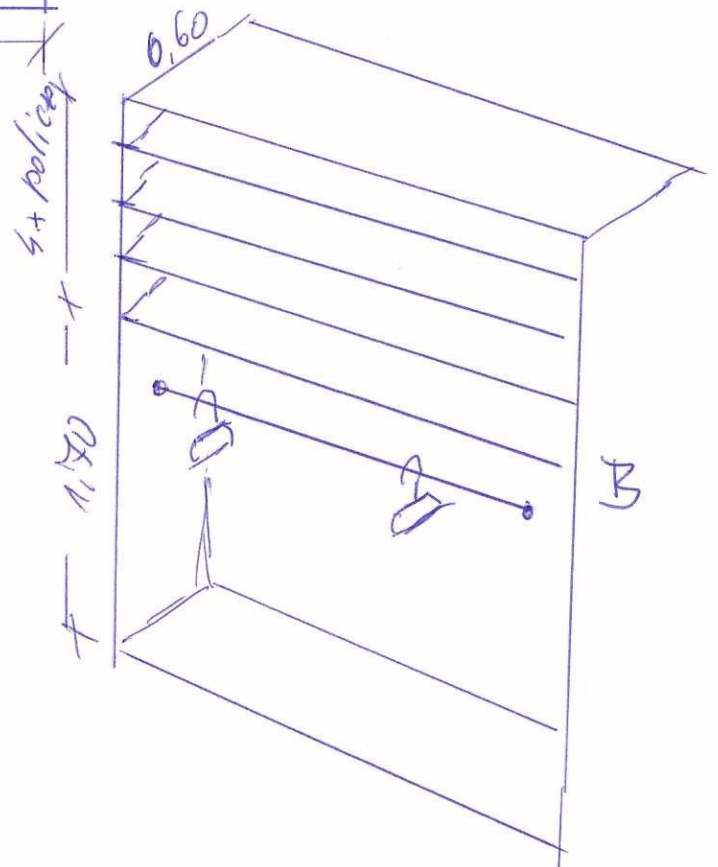
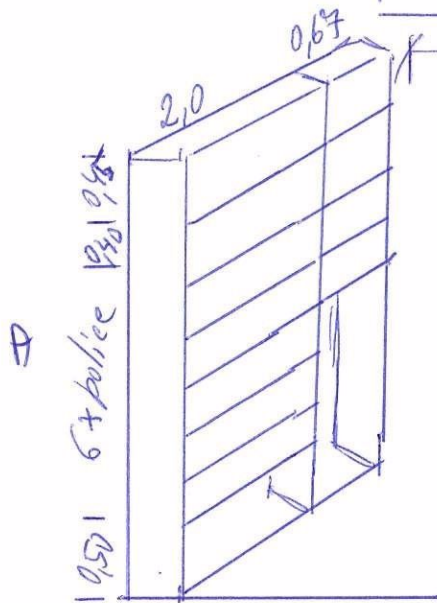
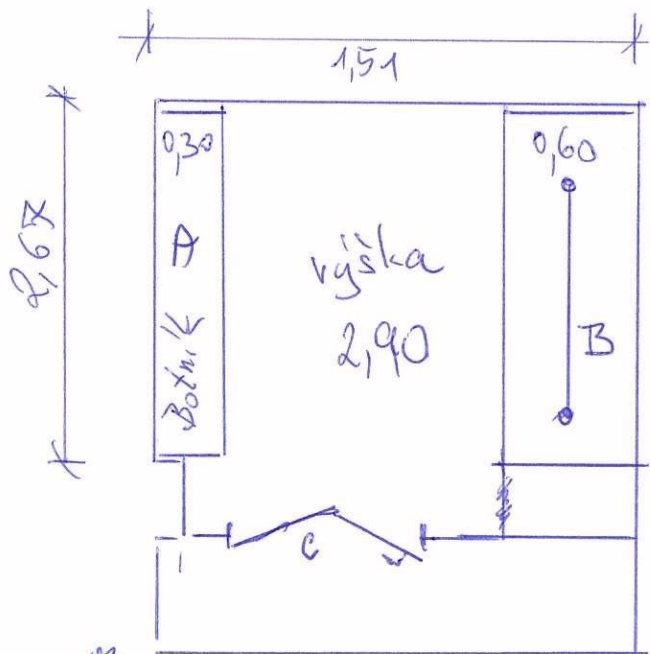

Deska + dveře skládná z materiálu desky