

General :
 - Pupitre fabriqué en acier doux

Soudure :
 - Procédé de soudage : MIG
 - cordons de soudure : 0,7 x l'épaisseur minimum

Acier :
 - Nuance de l'acier : S235 JRH
 - Tolérance des épaisseurs : + ou - 10% pour des épaisseurs inférieures ou égales à 5 mm

Traitement de surface :
 - Peinture monocouche antirouille RAL6029

9
 Dé
 Dé
 Pl
 Ré
 RI



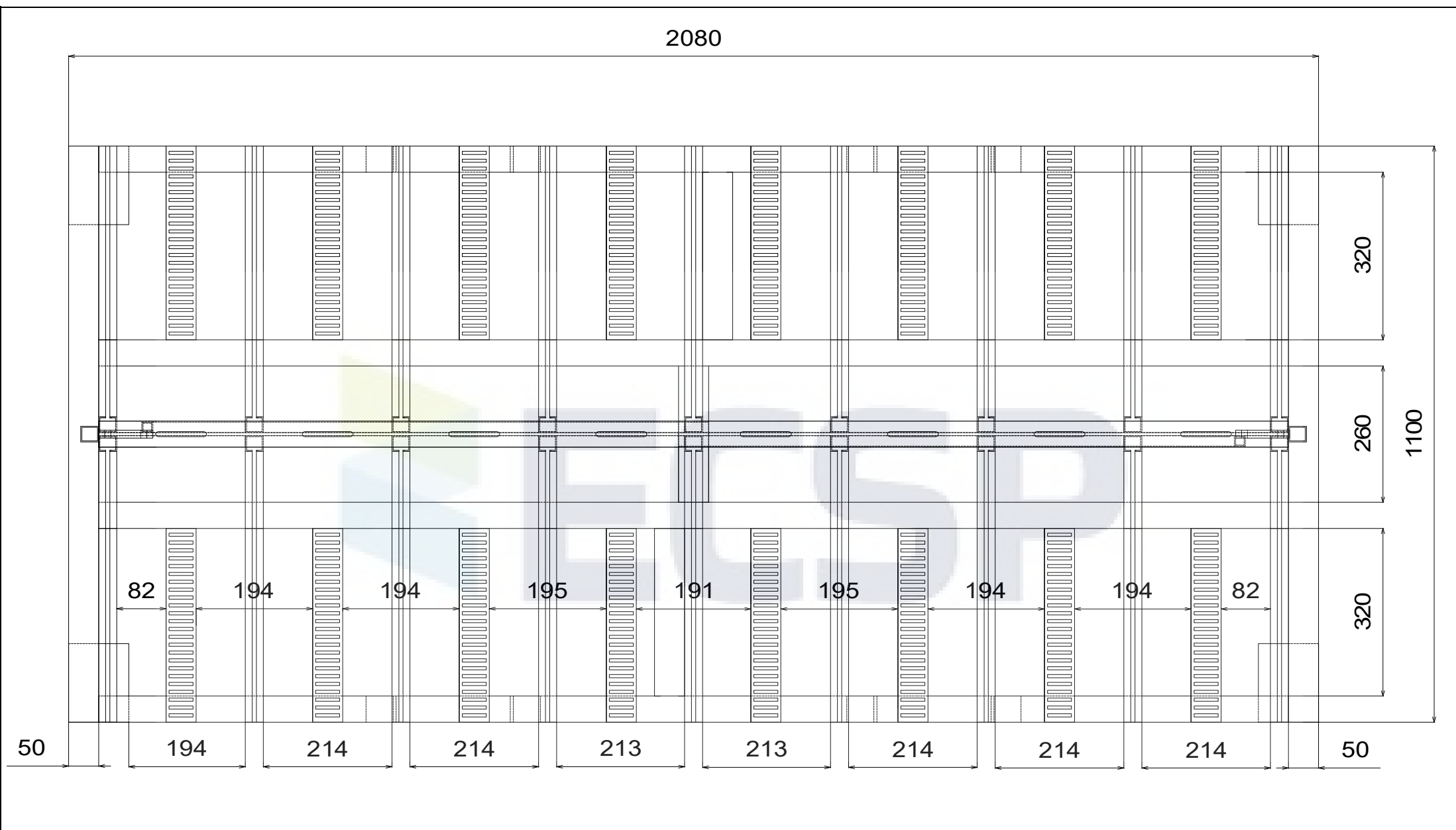

General :
-

Soudure :
- Procédé de soudage : MIG
- cordons de soudure : 0,7 x l'épaisseur minimum

Acier :
- Nuance de l'acier : S235 JRH
- Tolérance des épaisseurs : + ou - 10% pour des épaisseurs inférieures ou égales à 5 mm

Traitement de surface :
-

9
Dé
Dè
PI
Rè
RI



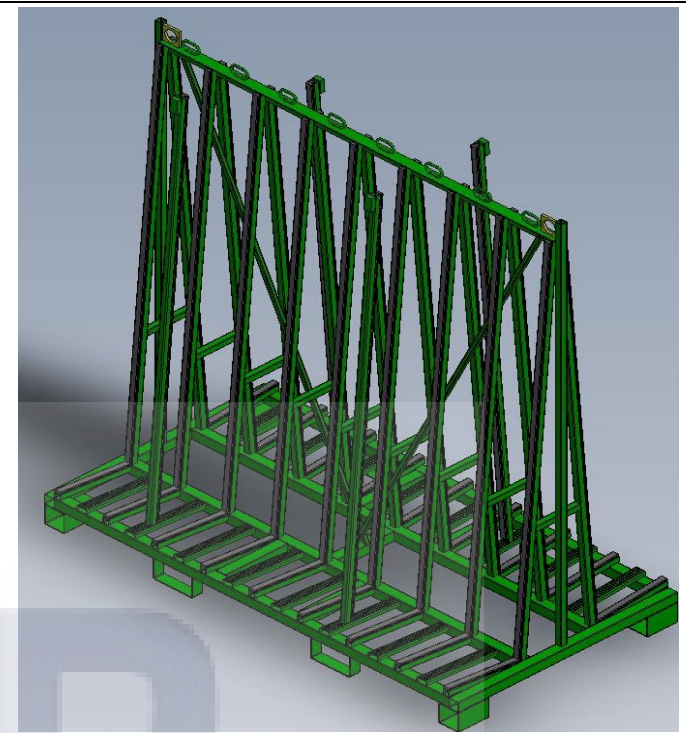
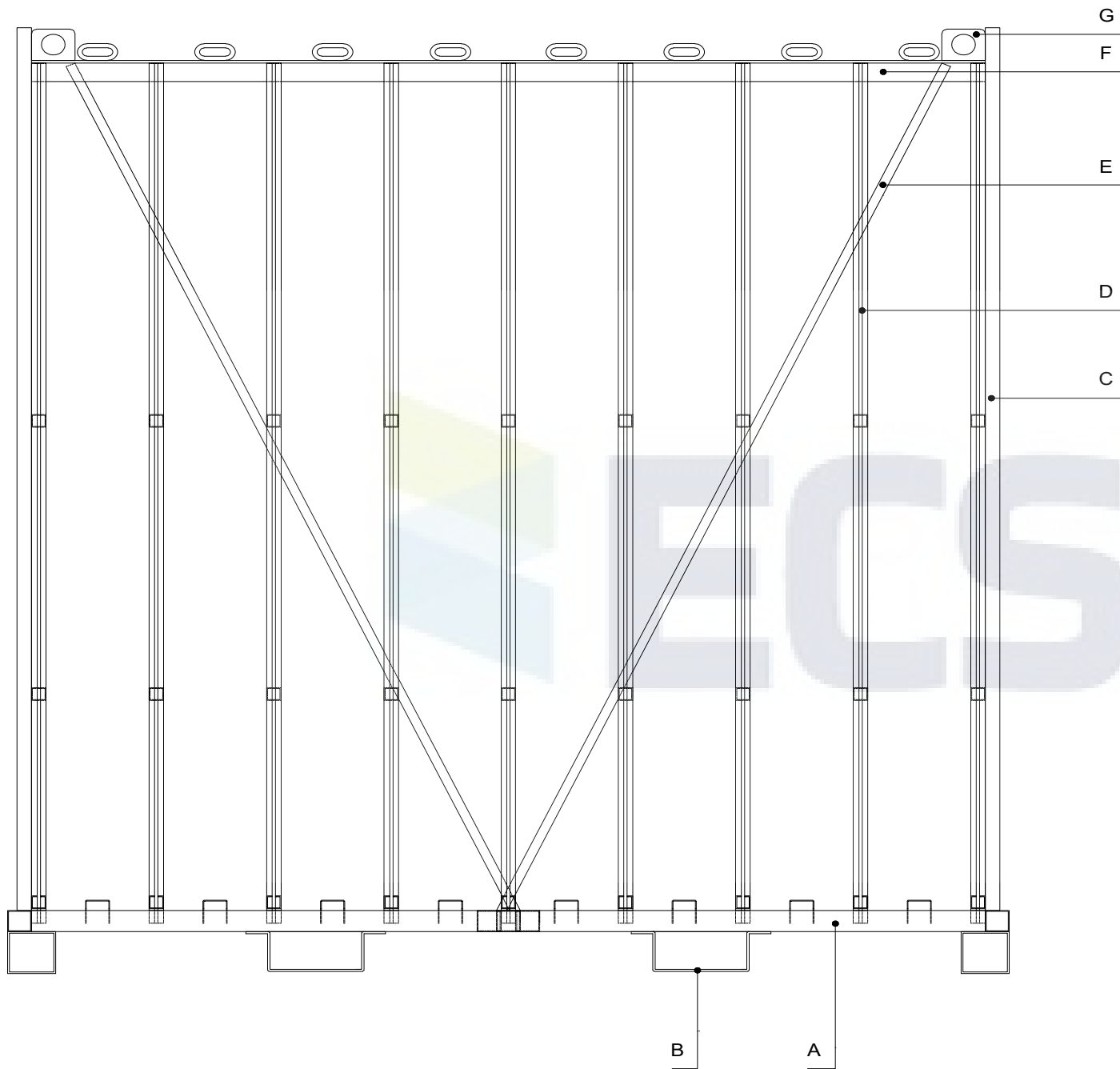

NOMENCLATURE

REP	MATIERE	SECTION	LONGUEUR	QUANTITE
N				
M				
L				
K				
J				
I				
H				
G	PLAT	90X15	75 mm	2
F	FER T	50X50X6	1980 mm	1
E	TUBE	20X20X2	2220 mm	2
D	PROFILE	30X30X7X2	2020 mm	18
C	TUBE	30X30X2	2100 mm	2
B	PLAT	50X5	500 mm	4
A	TUBE	50X50X2	1980 mm	2

9
Dé
Dé
PI
Ré
RI



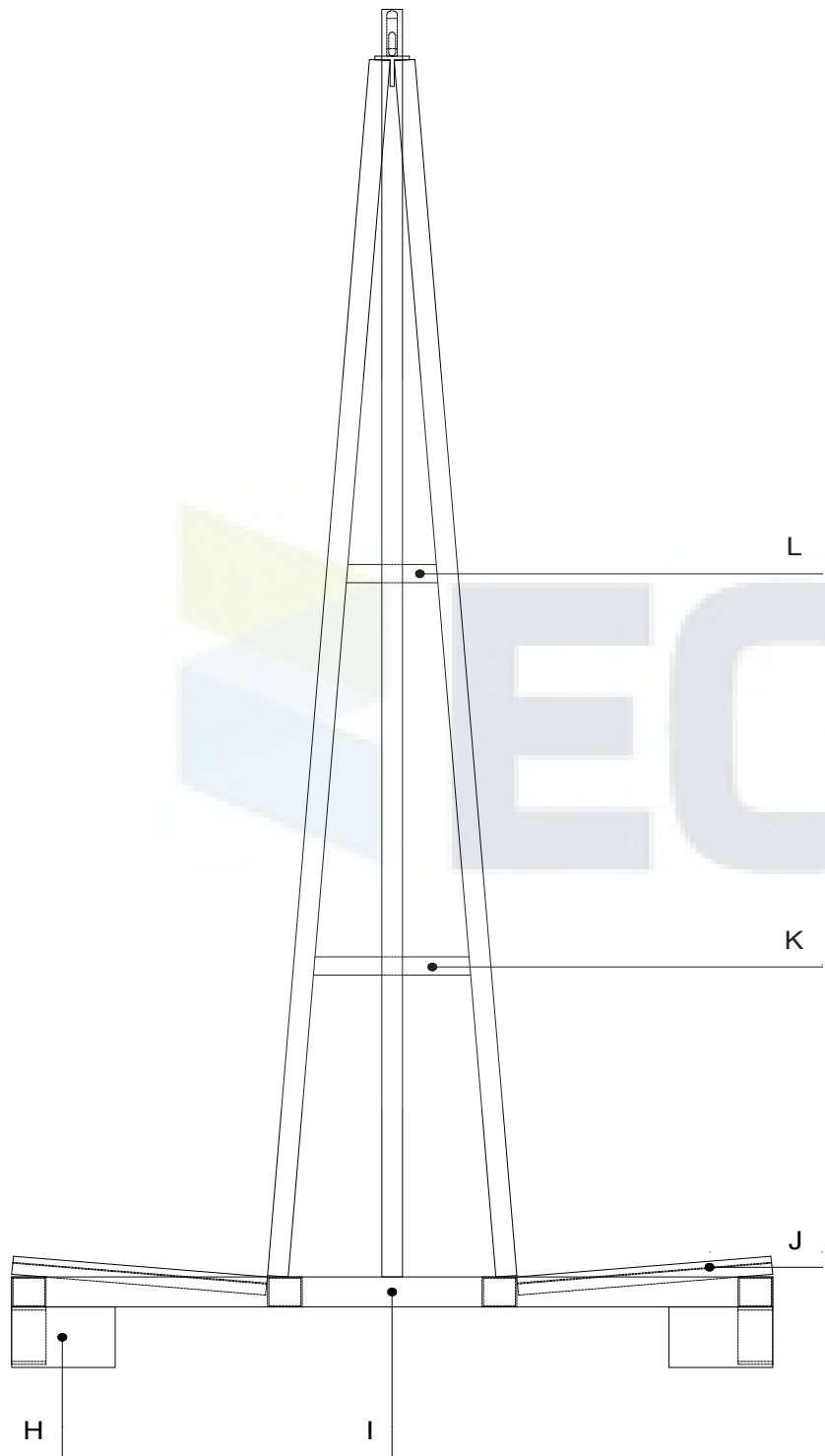

NOMENCLATURE

REP	MATIERE	SECTION	LONGUEUR	QUANTITE
L	TUBE	30X30X2	132 mm	9
K	TUBE	30X30X2	227 mm	9
J	PROFILE	30X30X7X2	368 mm	18
I	TUBE	50X50X2	1100 mm	2
H	TUBE	100X100X4	150 mm	4

9
Dé
Dé
PI
Ré
RI





NOMENCLATURE

REP	MATIERE	SECTION	LONGUEUR	QUANTITE
P	TUBE	50X50X2	320 mm	1
O	TUBE	50X50X2	260 mm	1
N	TUBE	50X50X2	1980 mm	2
M	TUBE	50X50X2	320 mm	1

9
Dé
Dè
PI
Rè
RI



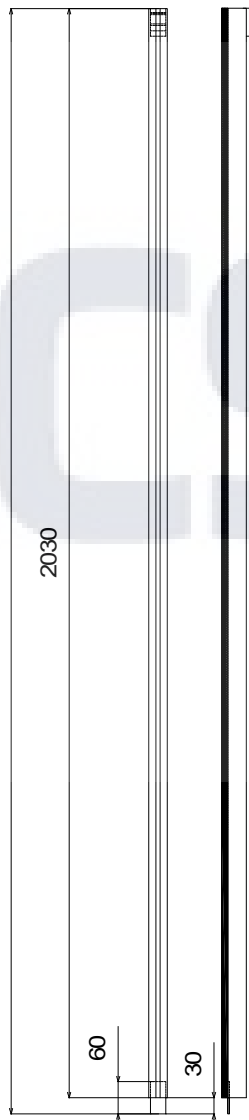
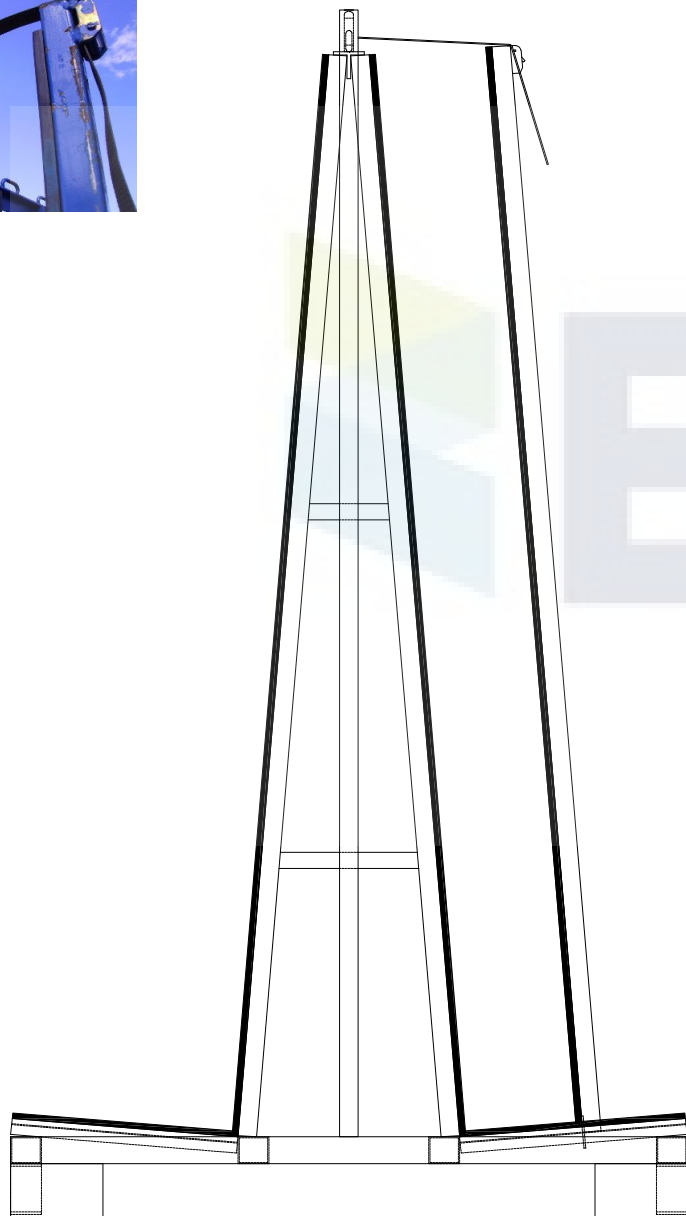

Q

R

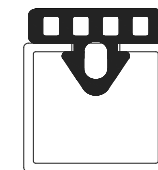

Caoutchouc alvéolé longueur 2030 mm

NOMENCLATURE

REP	MATIERE	SECTION	LONGUEUR	QUANTITE
R	PLAT	35X3	60 mm	6
Q	PROFILE	30X30X7X2	2030 mm	6

9
Dé
Dé
PI
Ré
RI



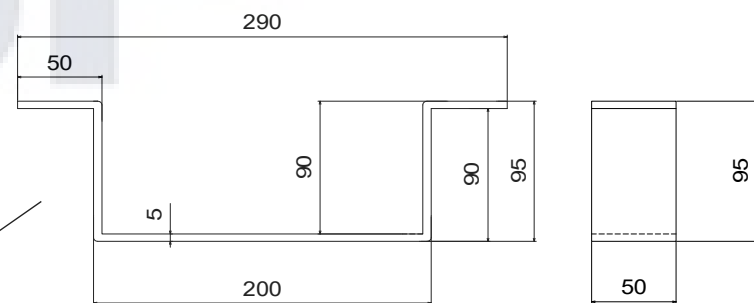
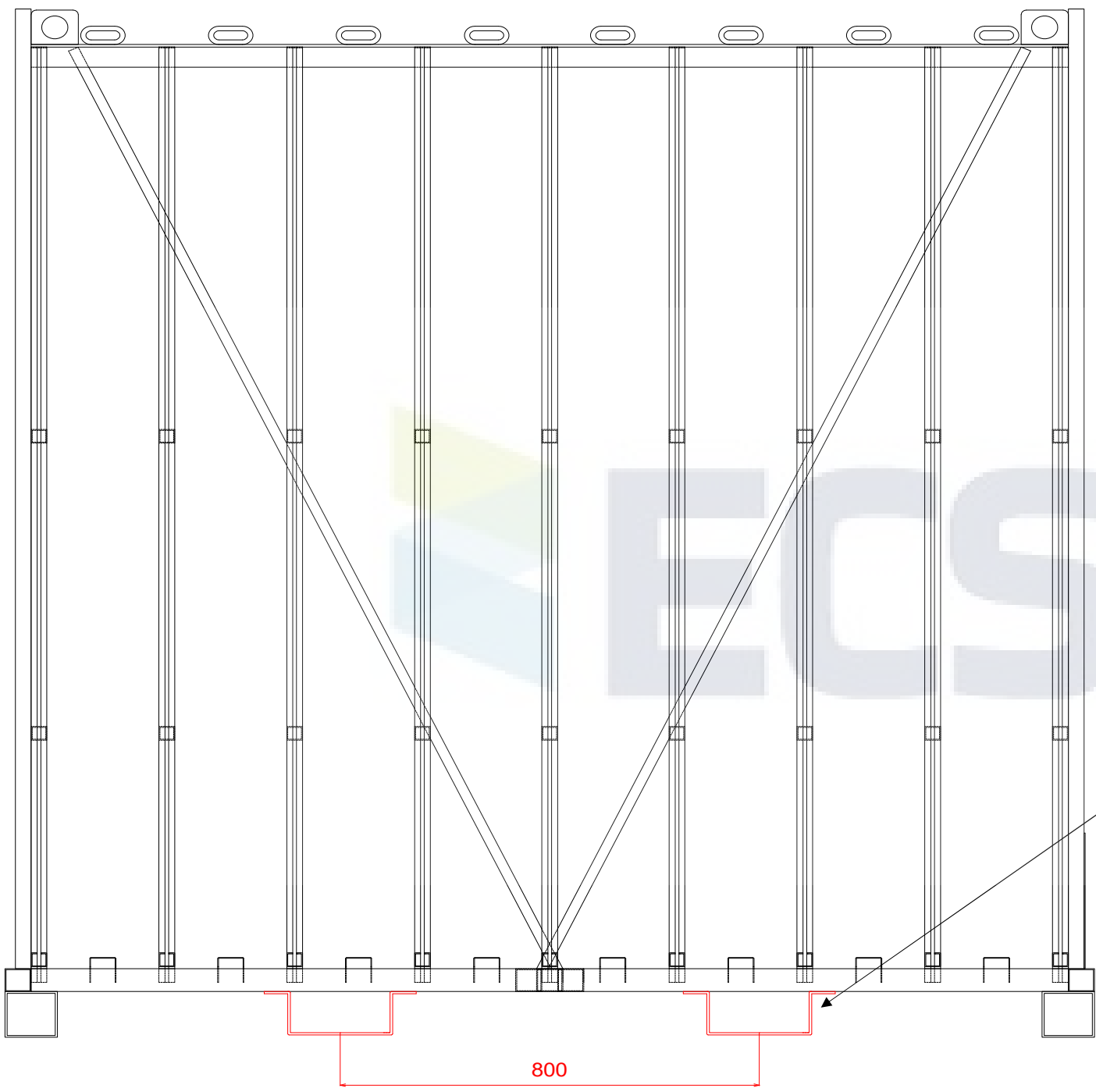

9
Dé
Dé
Pl
Ré
RI



1890

Les anneaux sont en peinture jaune

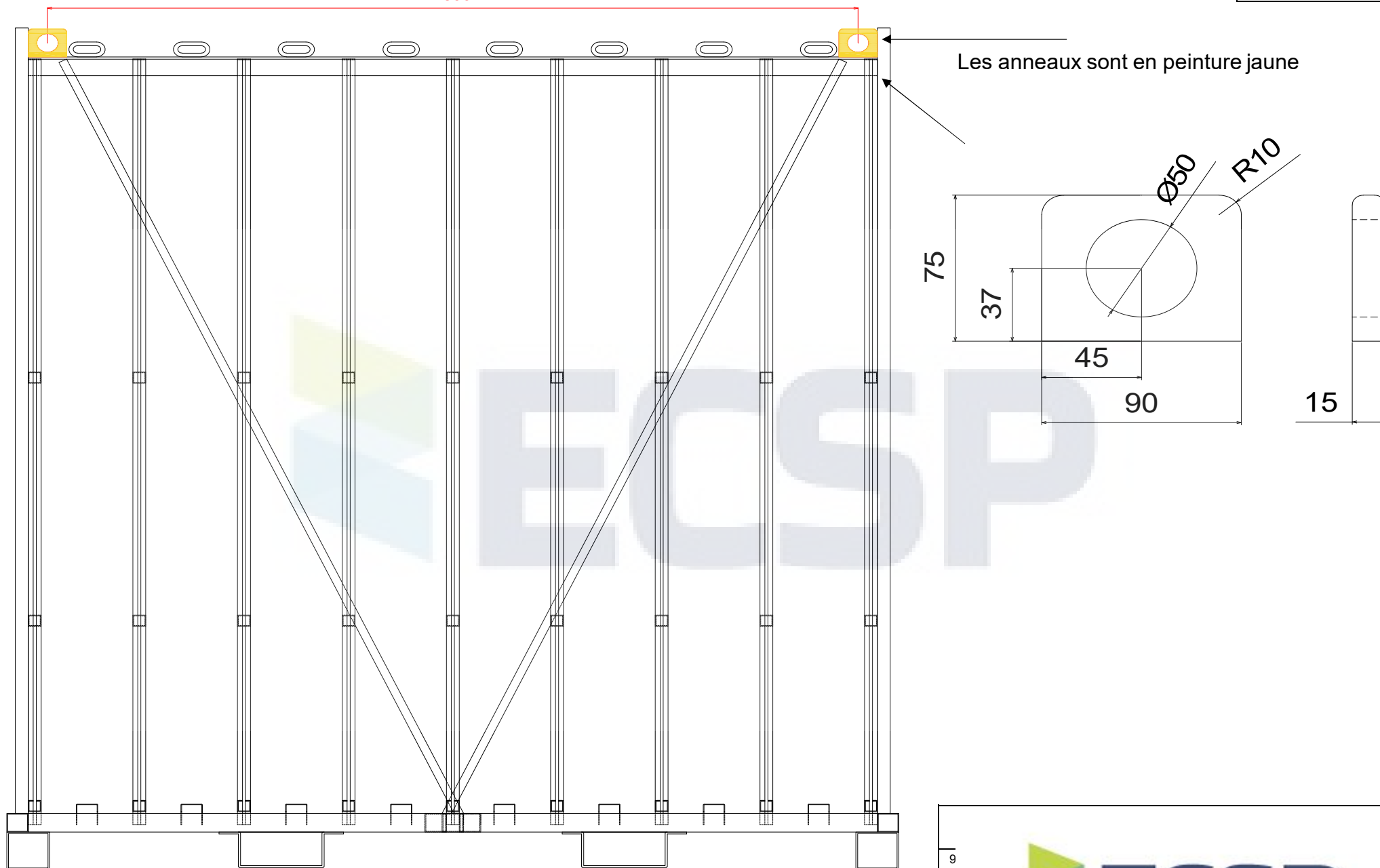

9
Dé
Dè
Pl
Rè
RI



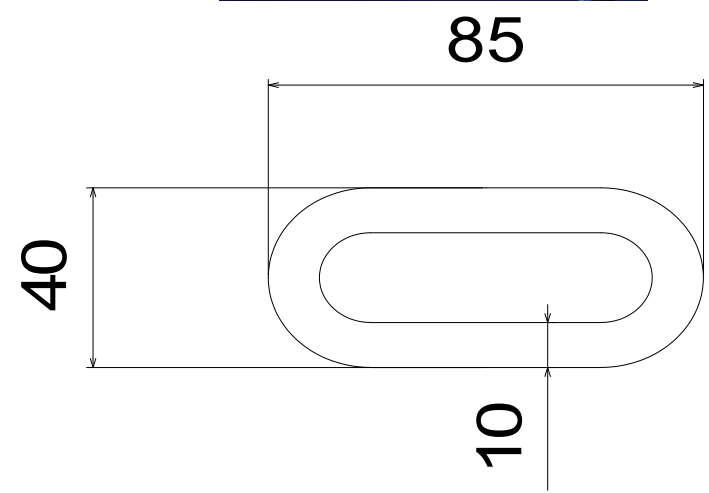
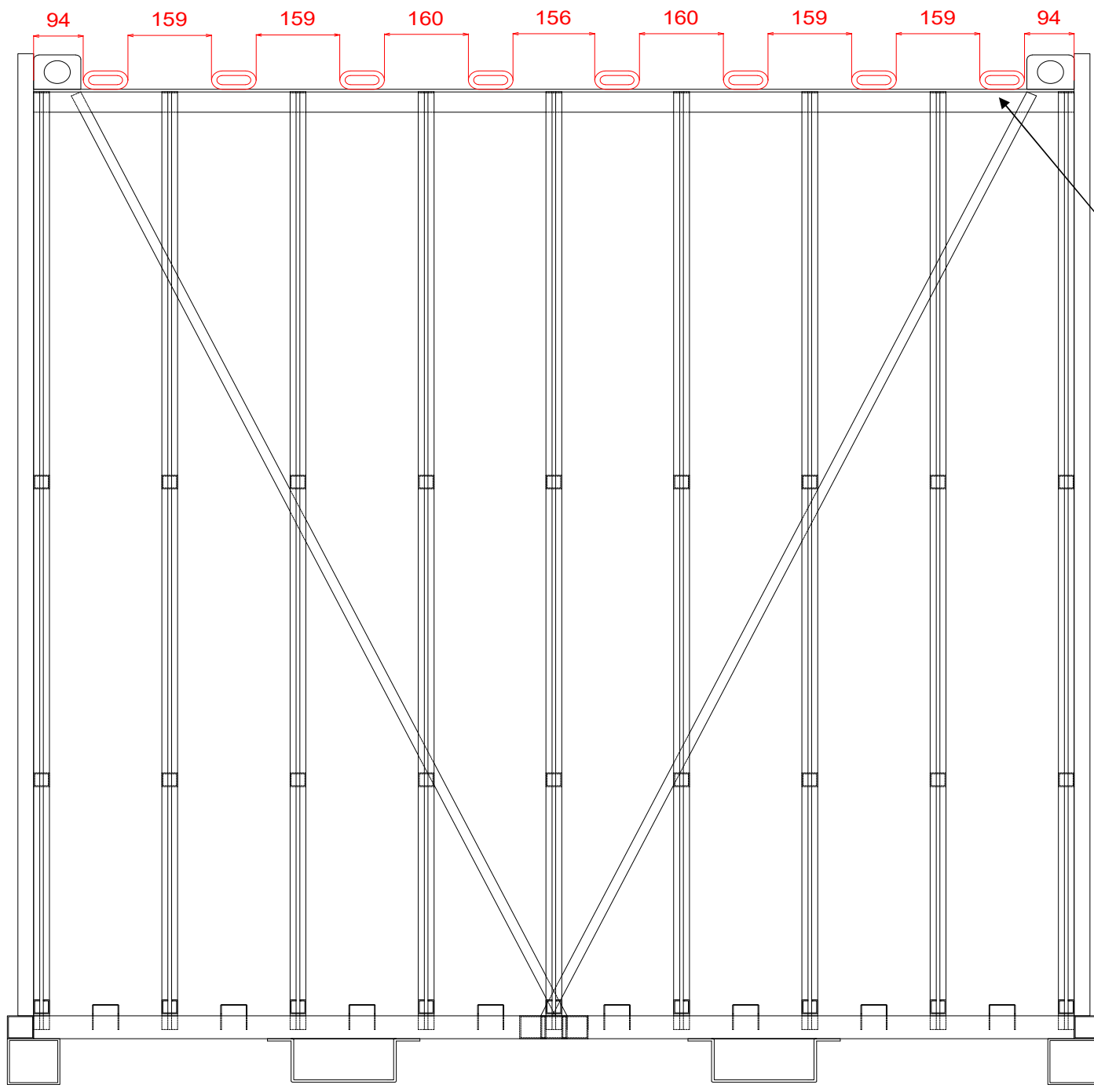

prendre un anneau de chaine qui ce rapproche le plus aux dimensions

9
Dé
Dé
Pl
Ré
RI



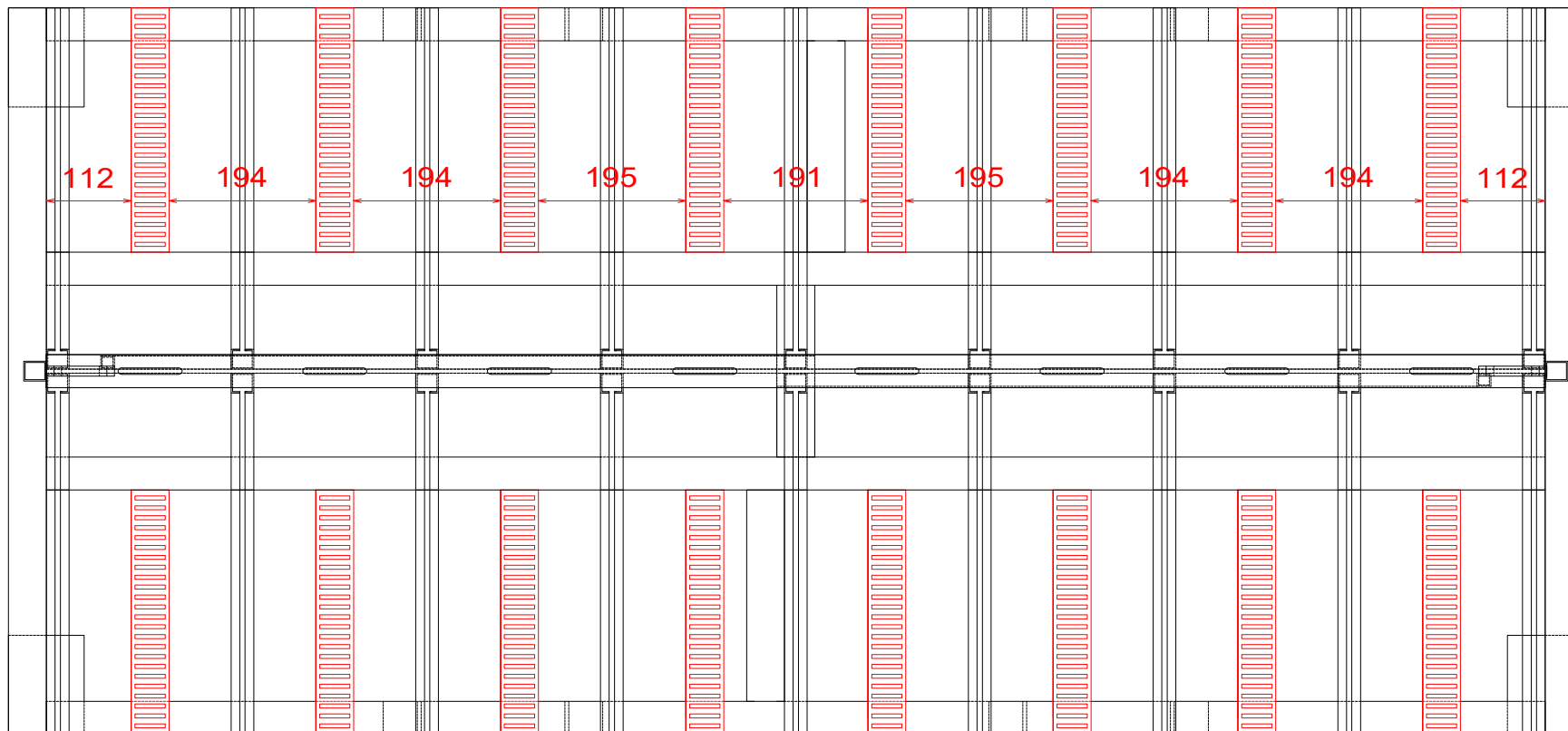

370

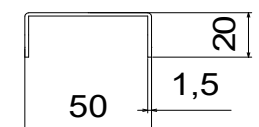
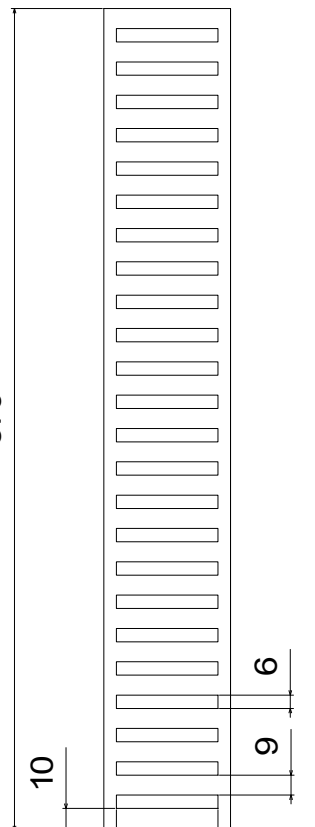

9
Dé
Dè
Pl
Rè
RI



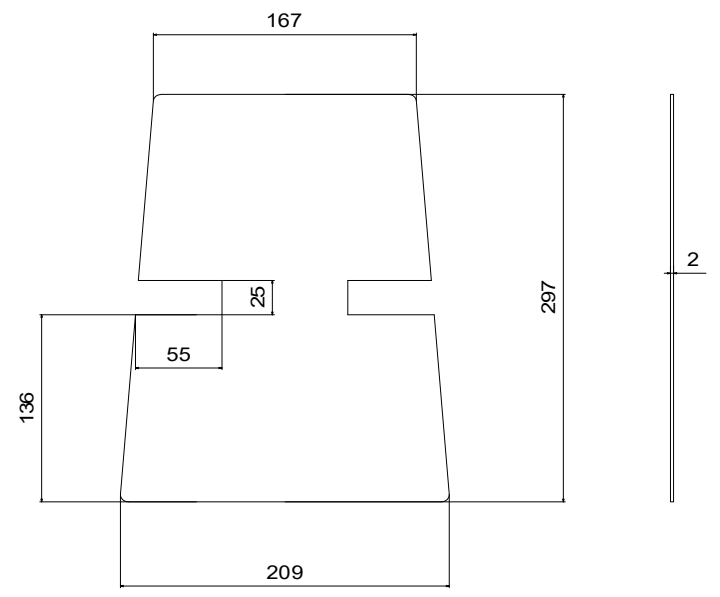
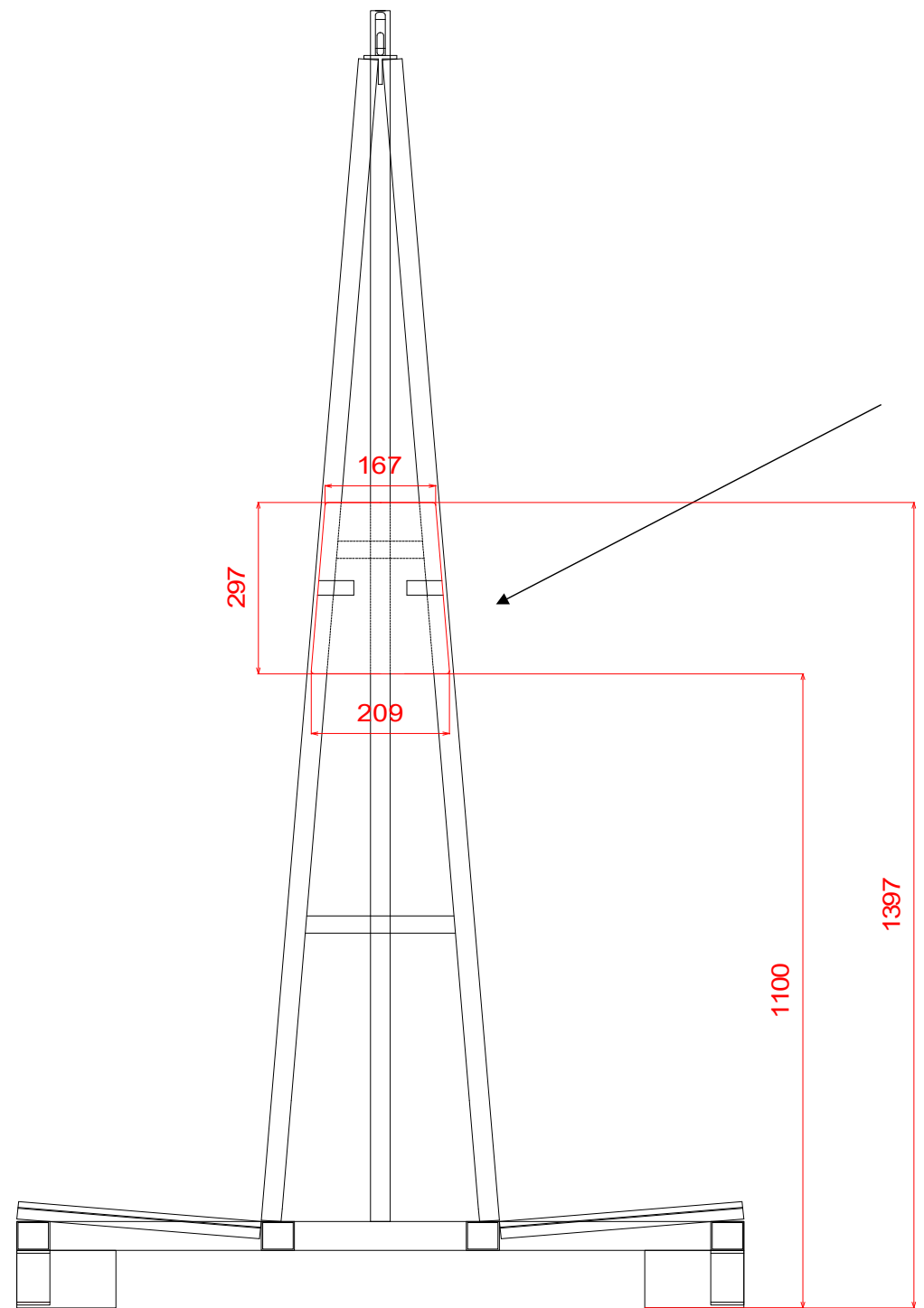
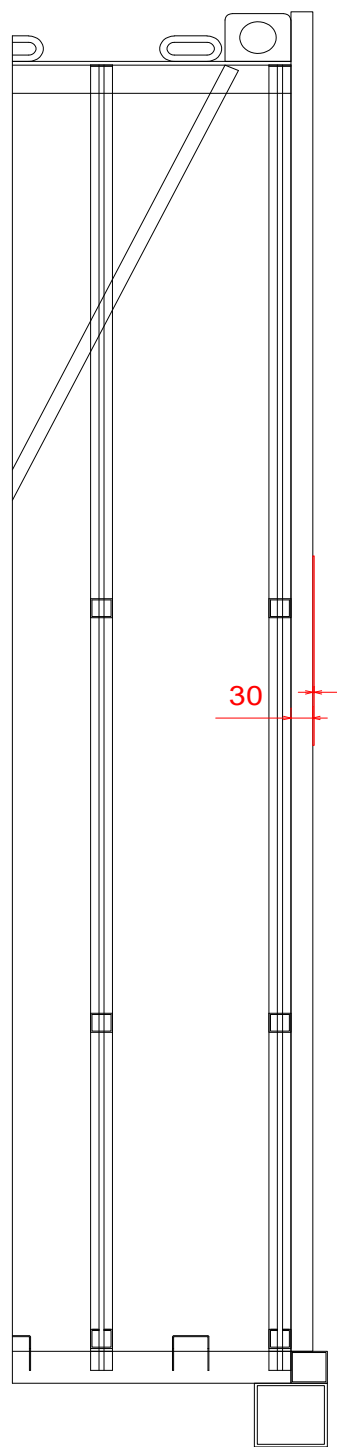

2 plaques

ECSP logo consisting of a stylized 'E' made of green and blue geometric shapes followed by the text 'ECSP' in blue. To the left of the logo is a vertical table with the following labels: 9, Dé, Dé, Pl, Ré, RI.

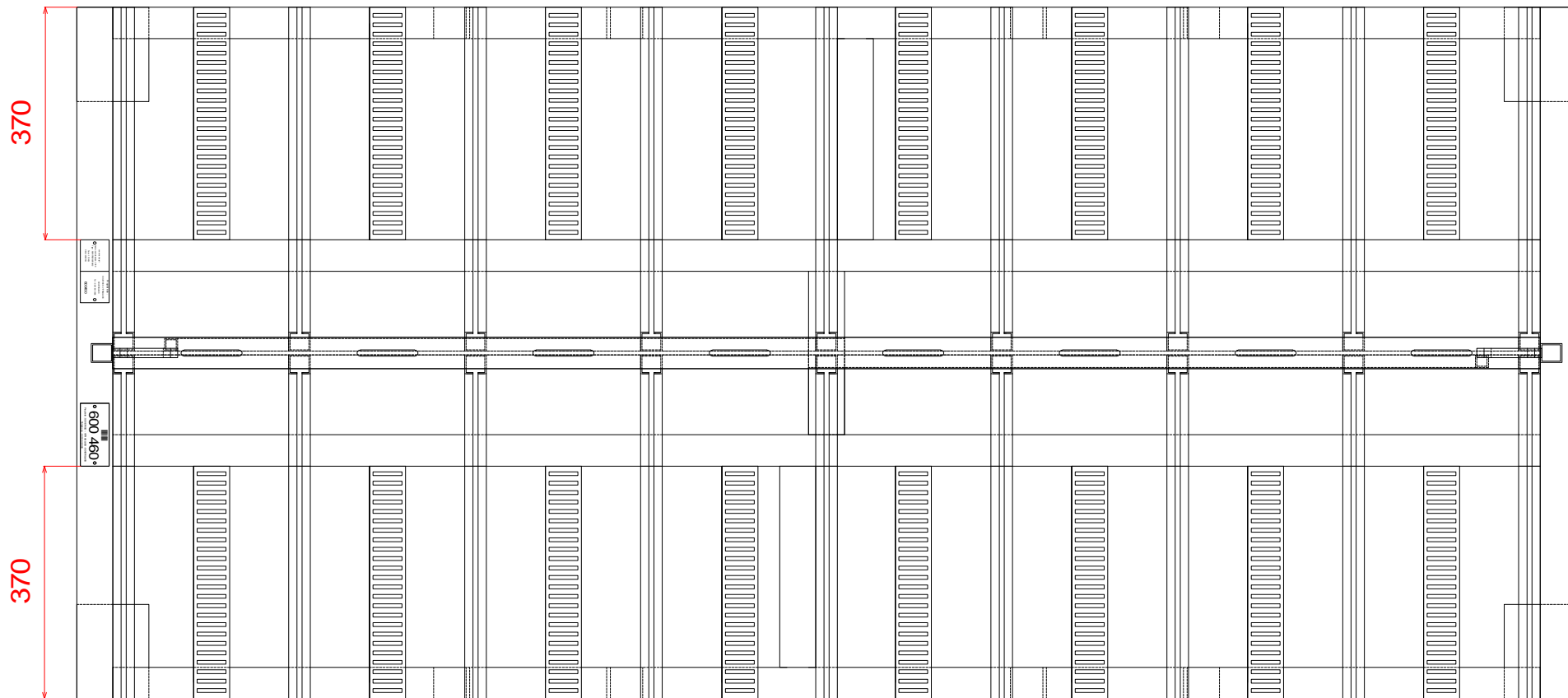

100



Tare : 175 KG
CMU: 2000 KG

600450

Plaque en aluminium
Longueur 100 mm
Largeur 40 mm
Epaisseur 0,5 mm

Numérotation de 600450 à 600549



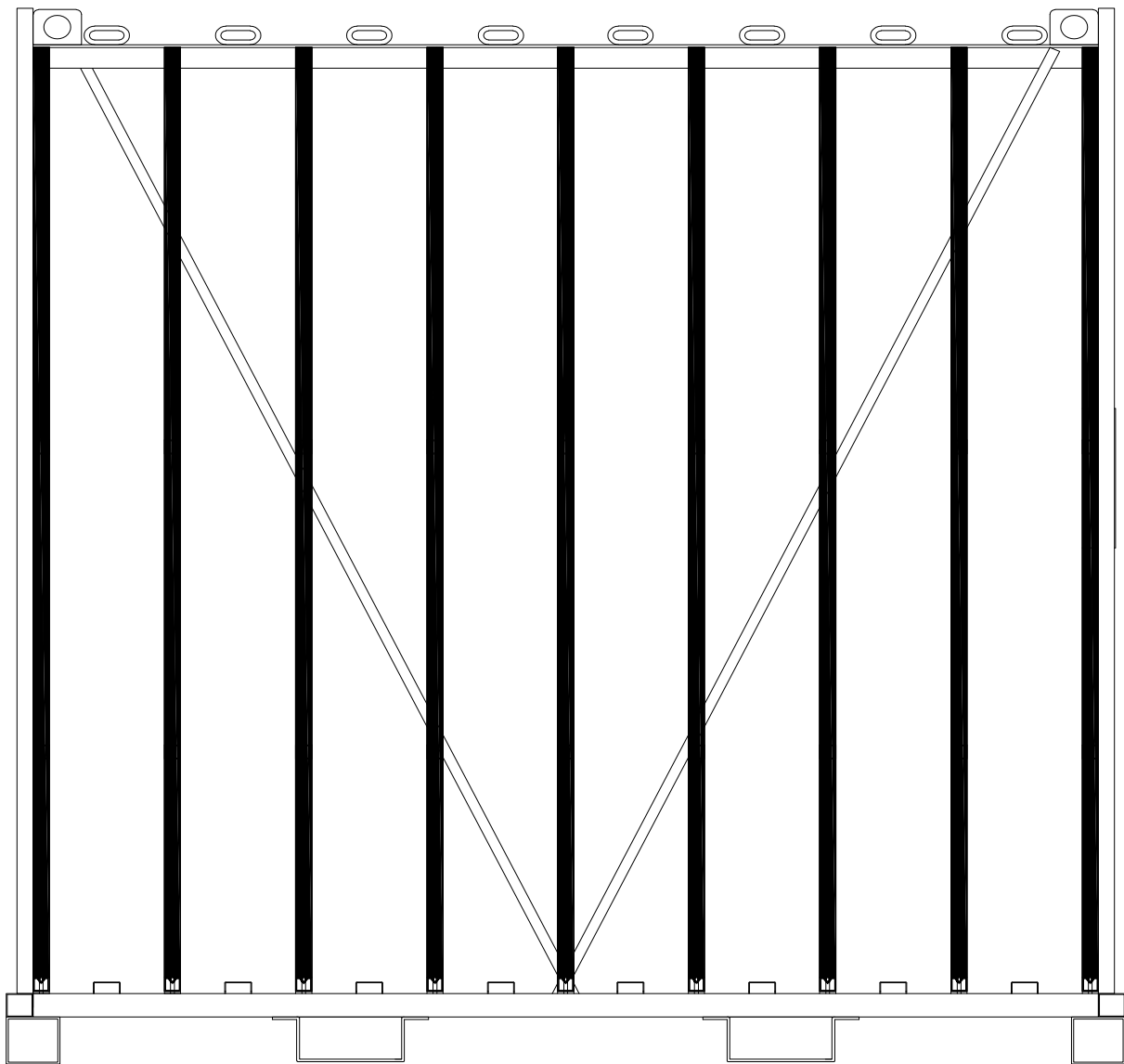

18 bandes de caoutchouc
alvéolé
longueur 2010 mm

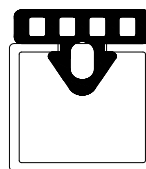

18 bandes de caoutchouc
alvéolé
longueur 370 mm

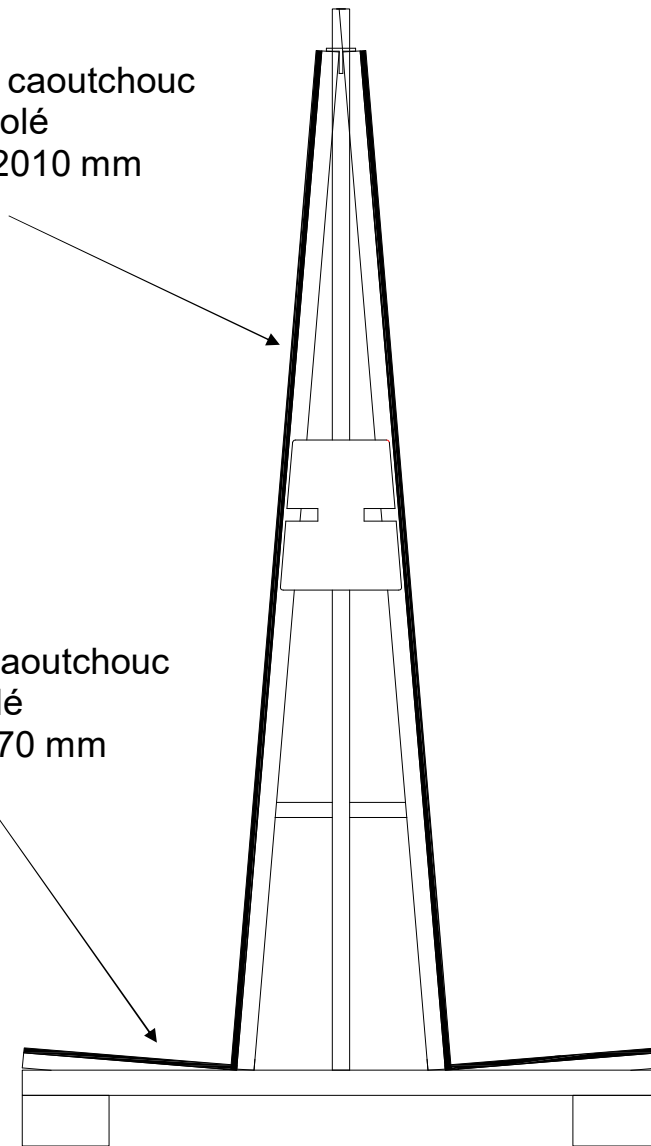
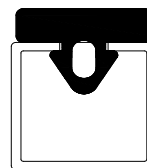

9
Dé
Dé
PI
Ré
RI



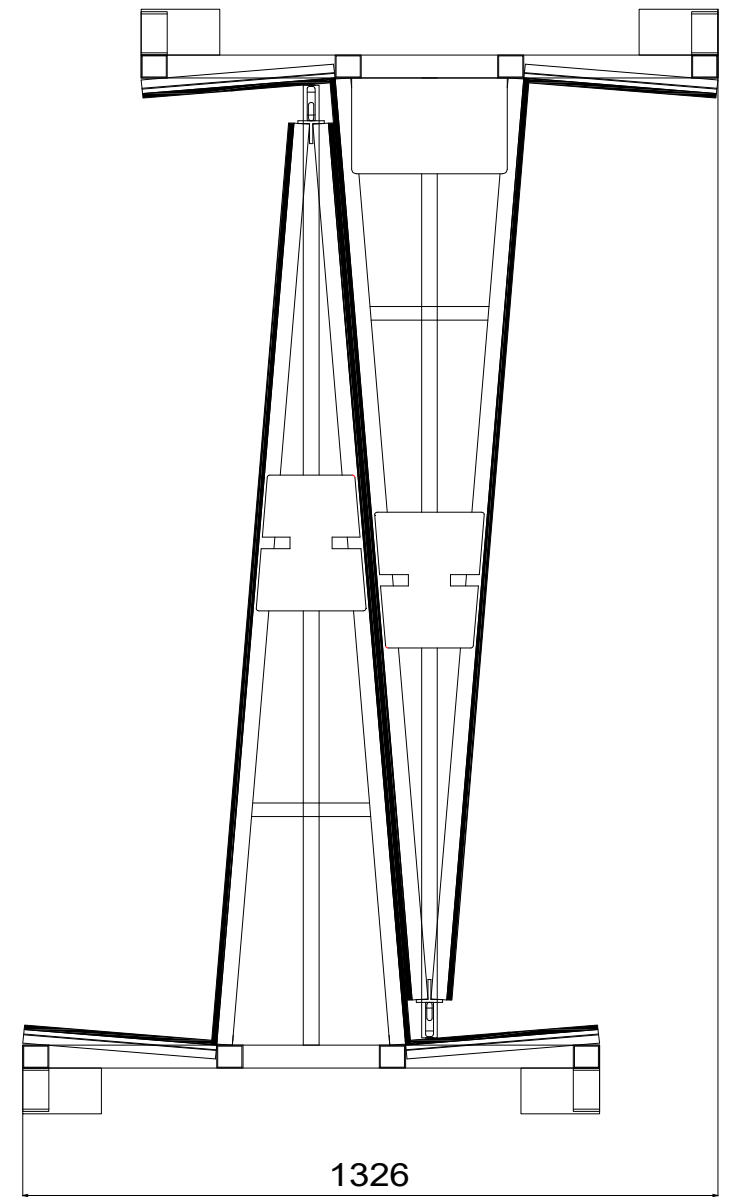
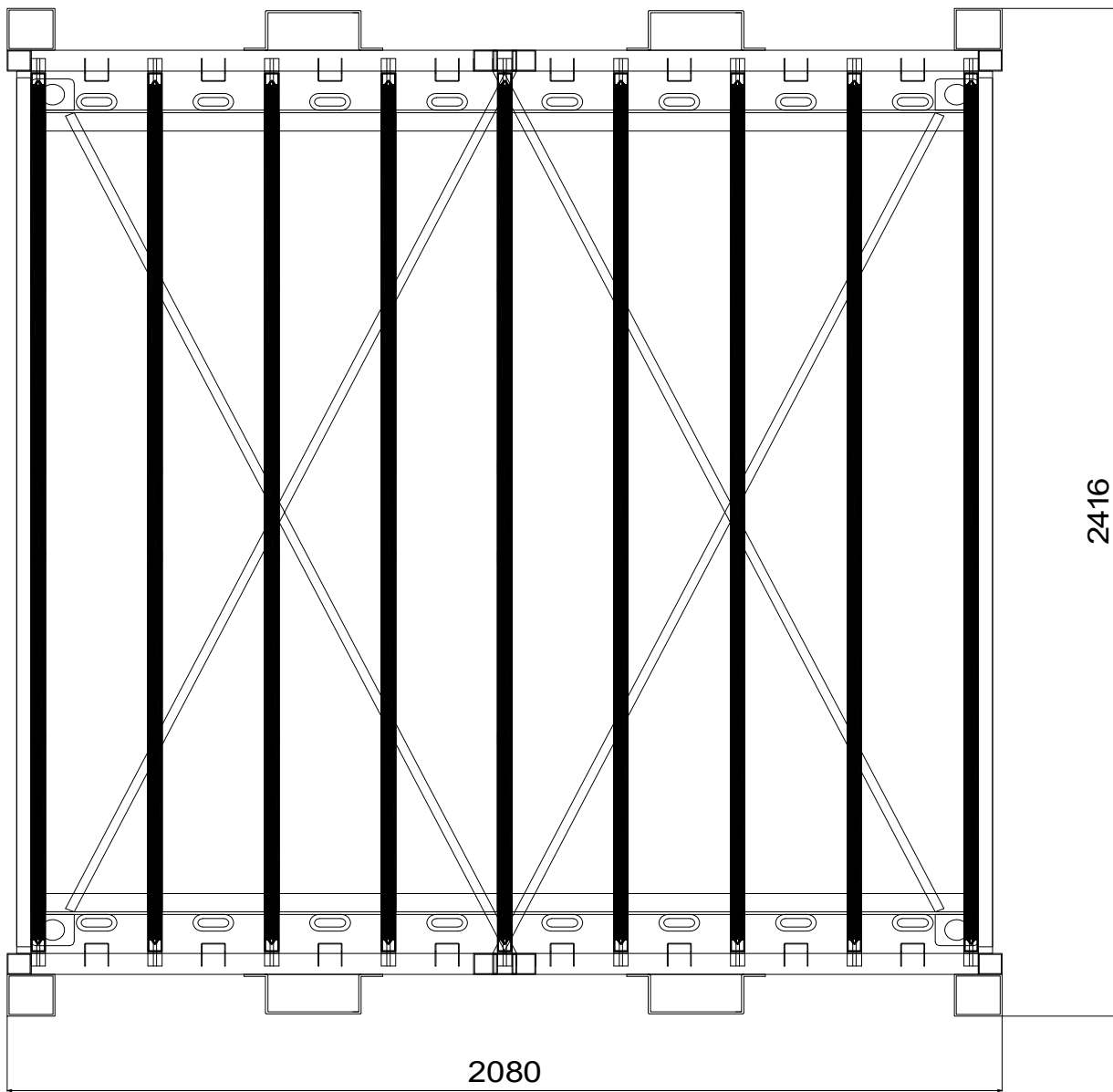

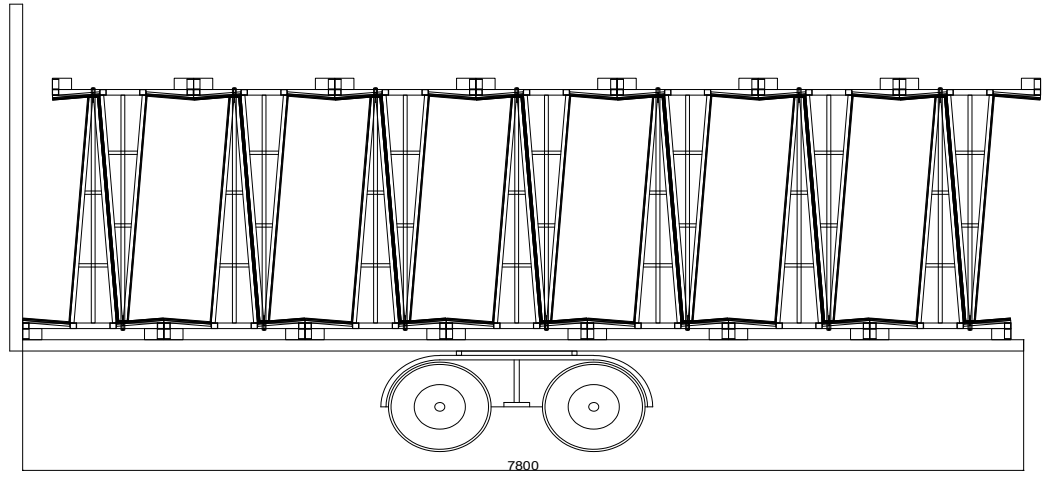
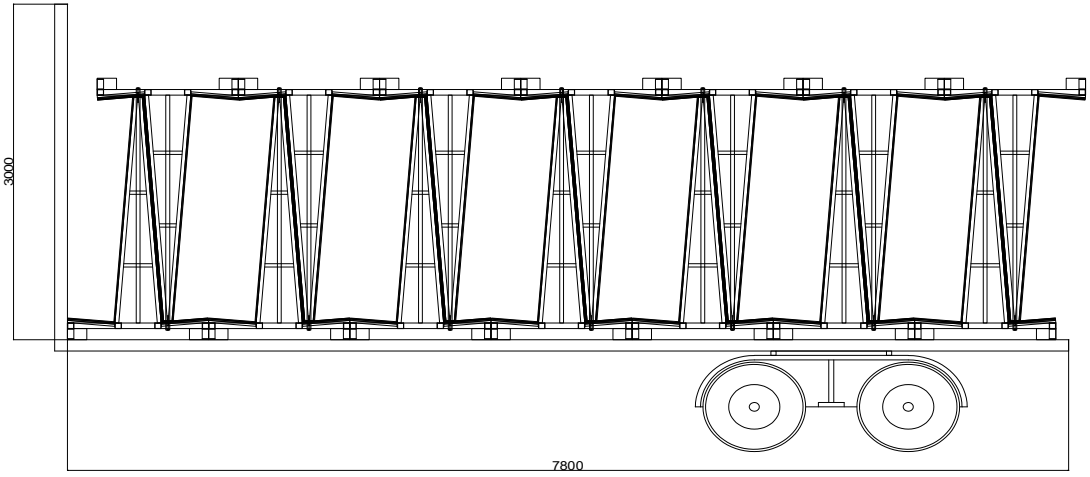
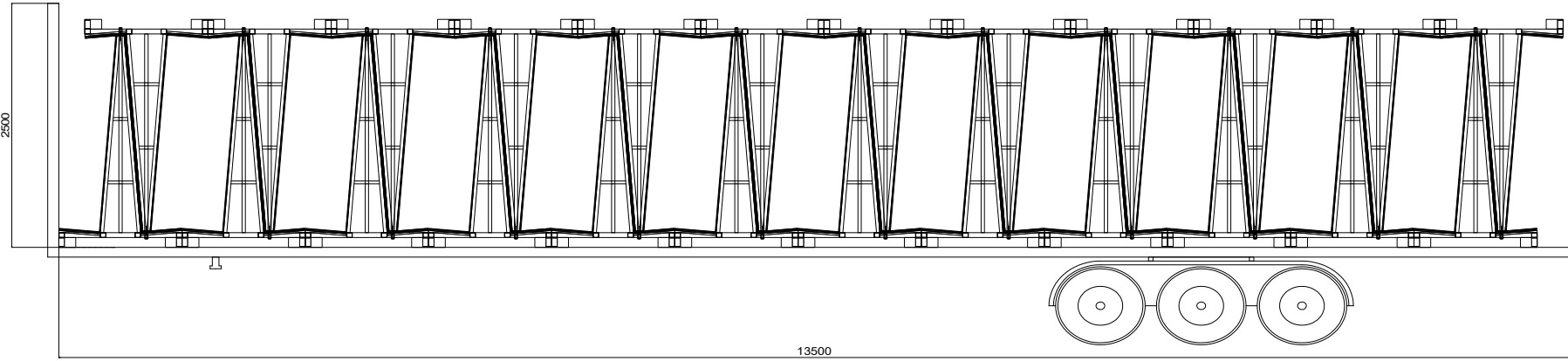

9
Dé
Dé
PI
Rè
RI