

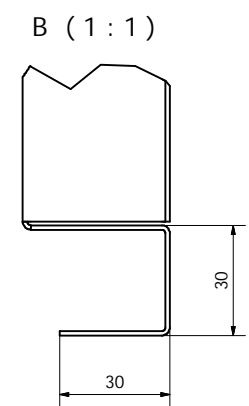

M (1 : 5)

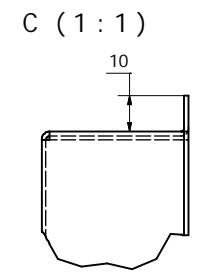

A (1 : 1)

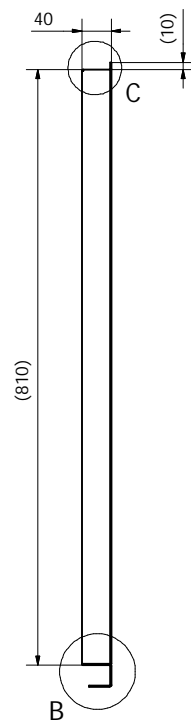
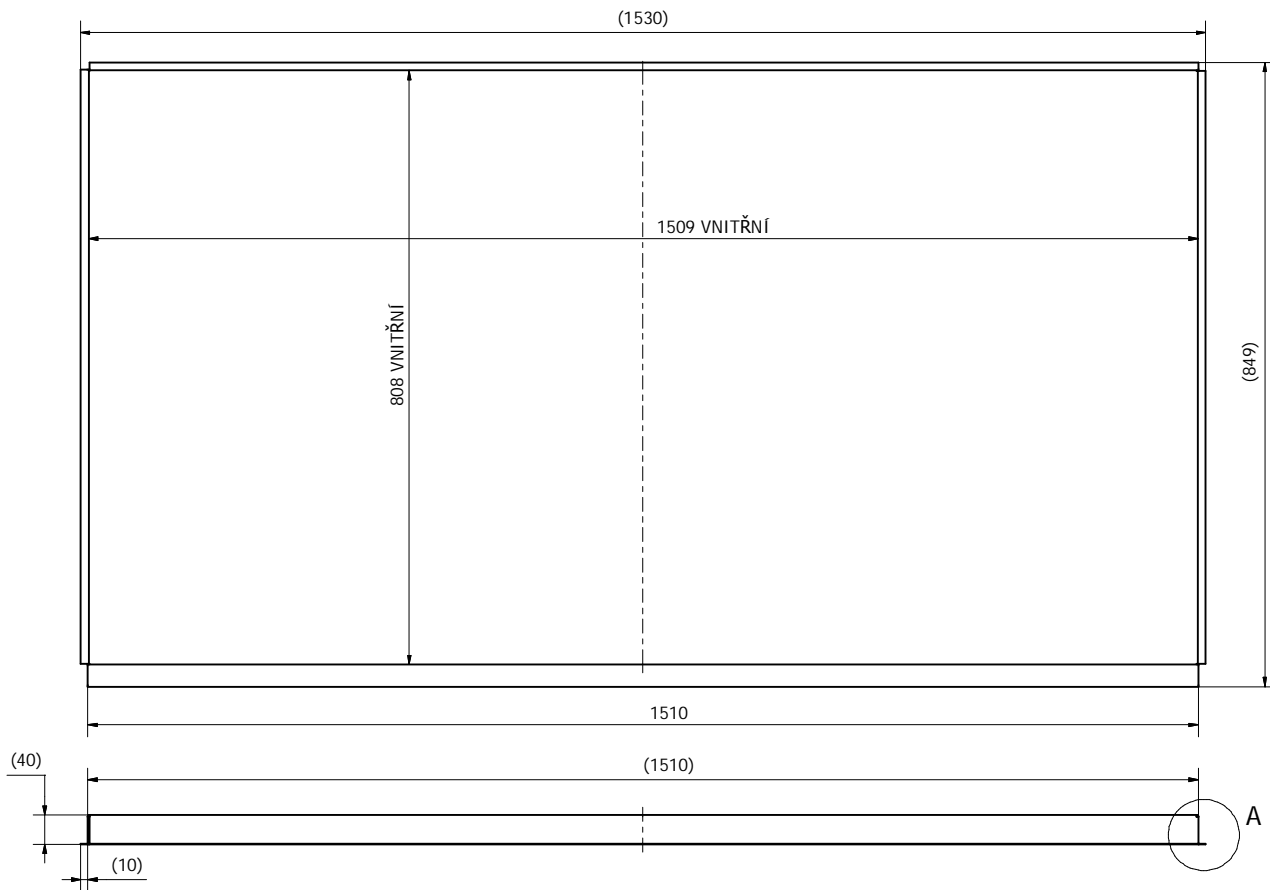
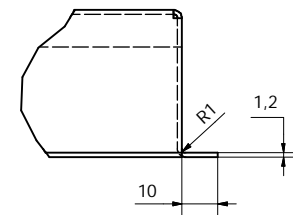

ROZVIN

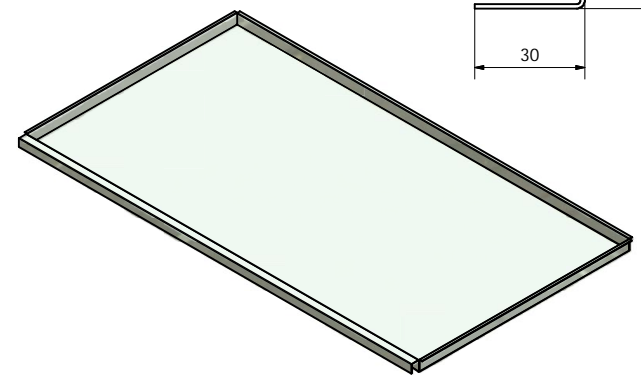
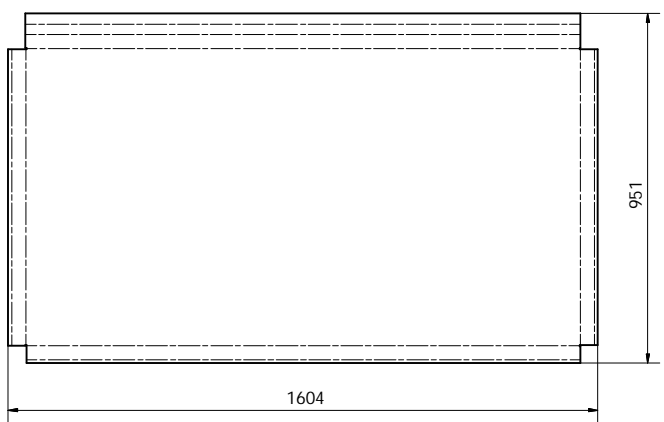

-POZINKOVANÝ PLECH 1.2 mm
-VNIŘNÍ R1