

DETAIL A
SCALE 3.000

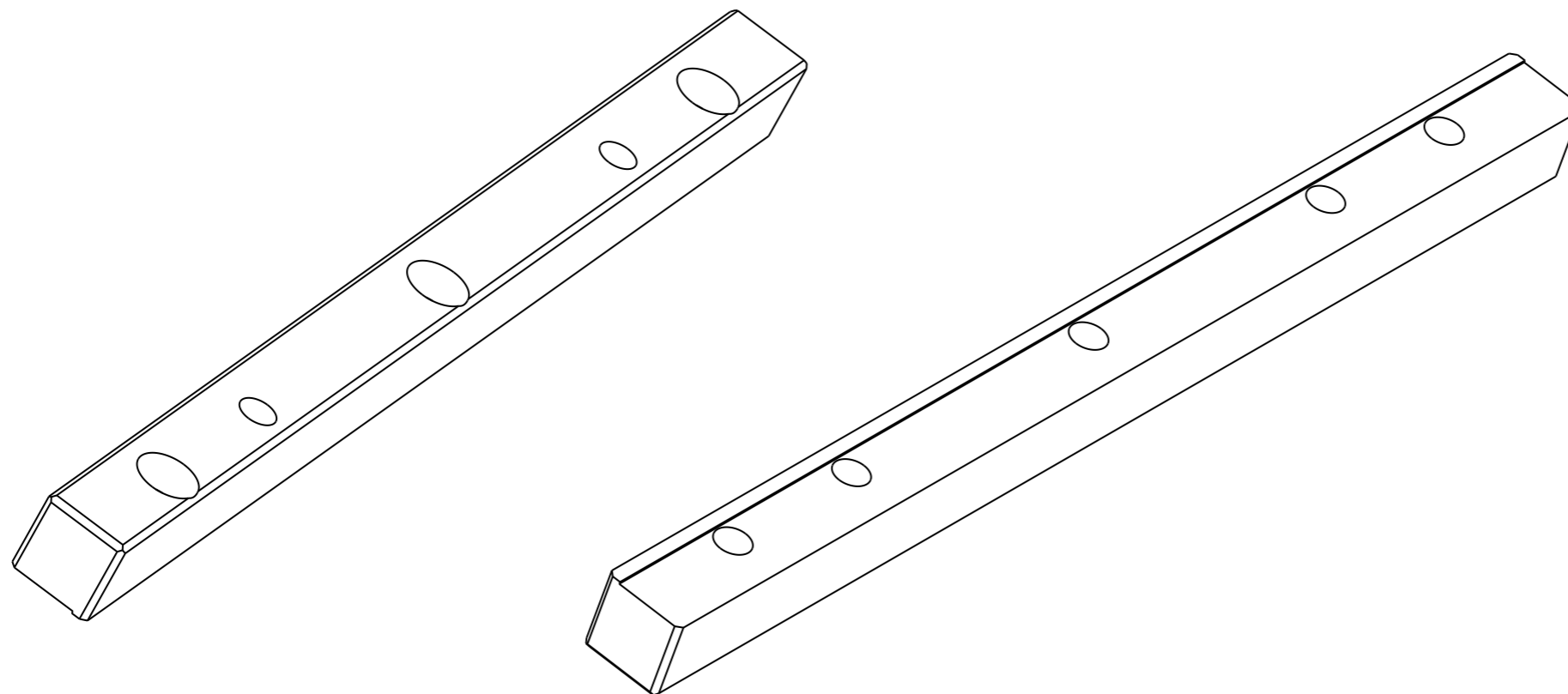
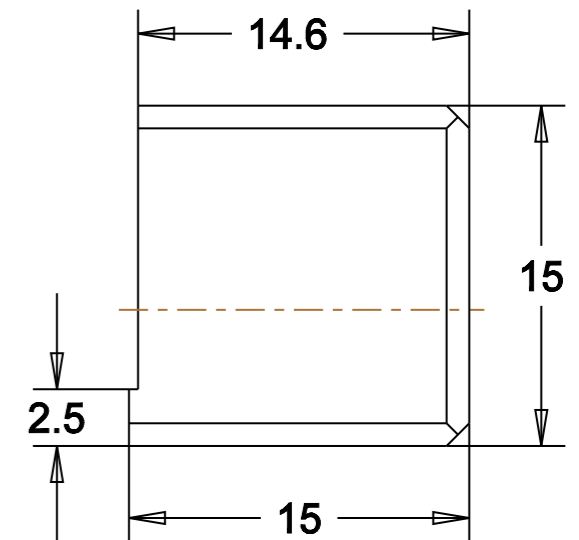

NETOL. ROZM. DLE ČSN ISO 2768mK

MĚŘÍTKO:	1:1	MATERIÁL:	St 37 k
CELK. OPAC.:	3.2 (✓)	TEPEL. ZPRAC.:	
NÁZEV:	PŘÍLOŽKA 2		
KRESLIL:	SLAVÍČEK JIŘÍ		
Č.V.:	109591-11-2010	Č.Č.:	3