

FOURNITURE ET MAITRISE D'OEUVRE DE SOLUTIONS INDUSTRIELLES ET MECANIQUES

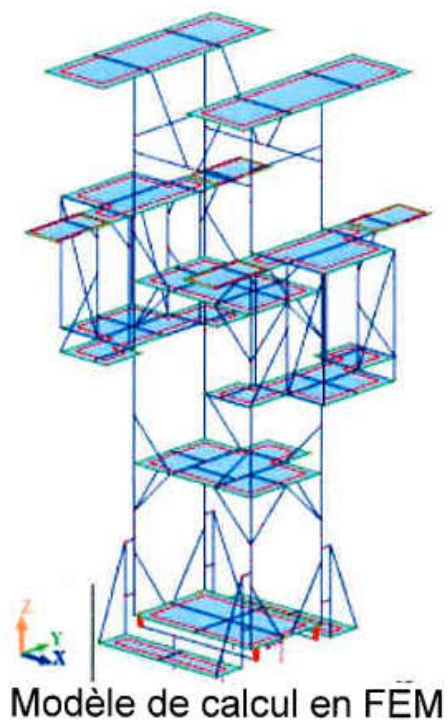

Nos Projets / Notre Savoir Faire

Projects / Knowledges



Etudes / *Studies*

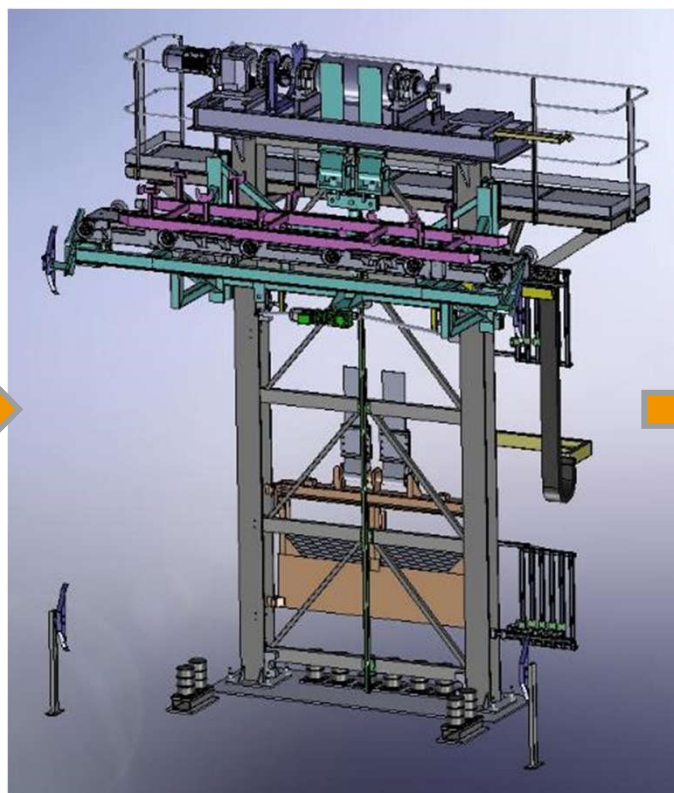

Conception / *Conception*



Production / *Production*

Petites et Moyennes Mécano Soudure

Small and middle size welding work



Petites et Moyennes Mécano Soudure

Small and middle size welding work



Petites et Moyennes Mécano Soudure

Small and middle size welding work



Mécano Soudure

Welding work



Mécano Soudure

Welding work



Mécano Soudure

Welding work







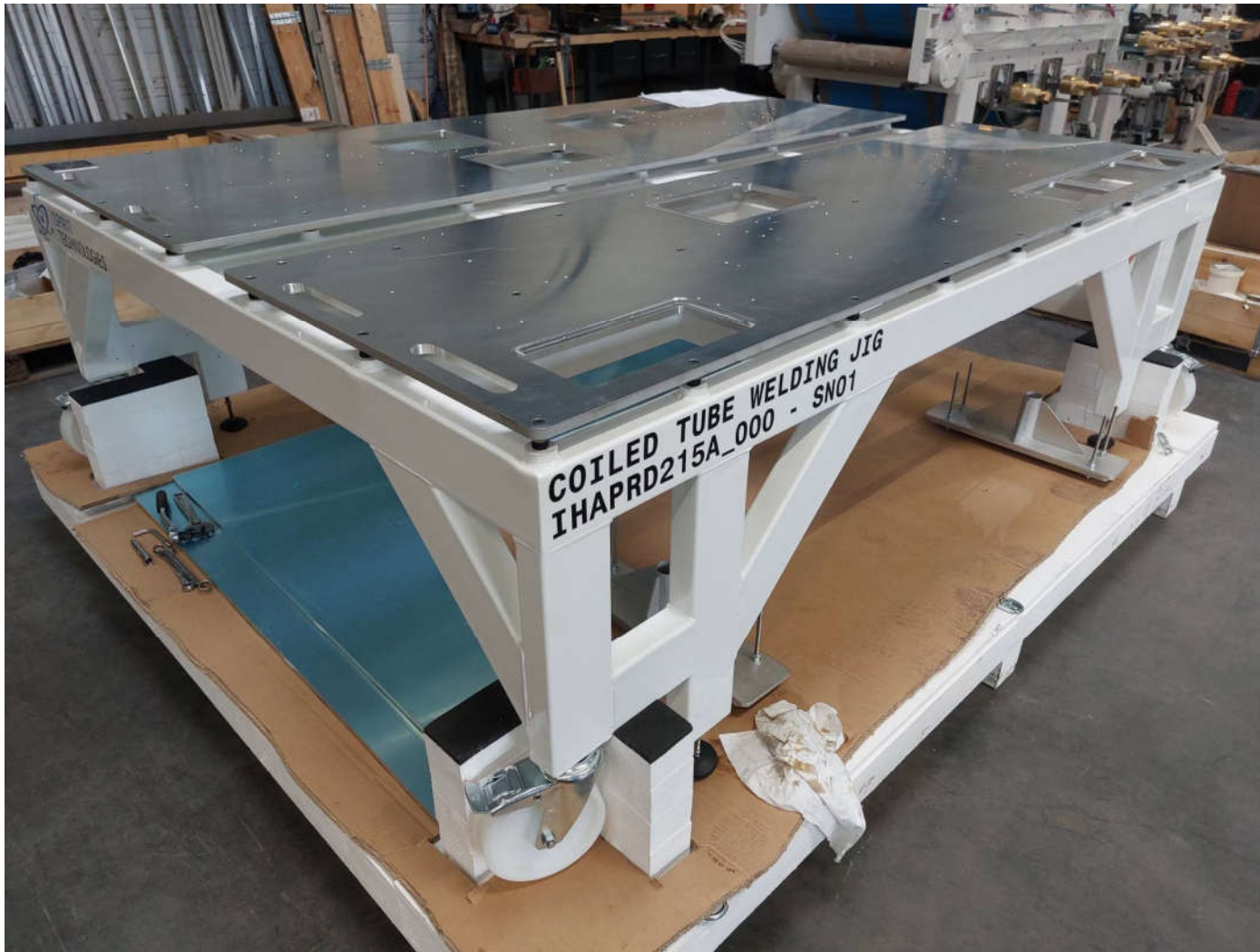



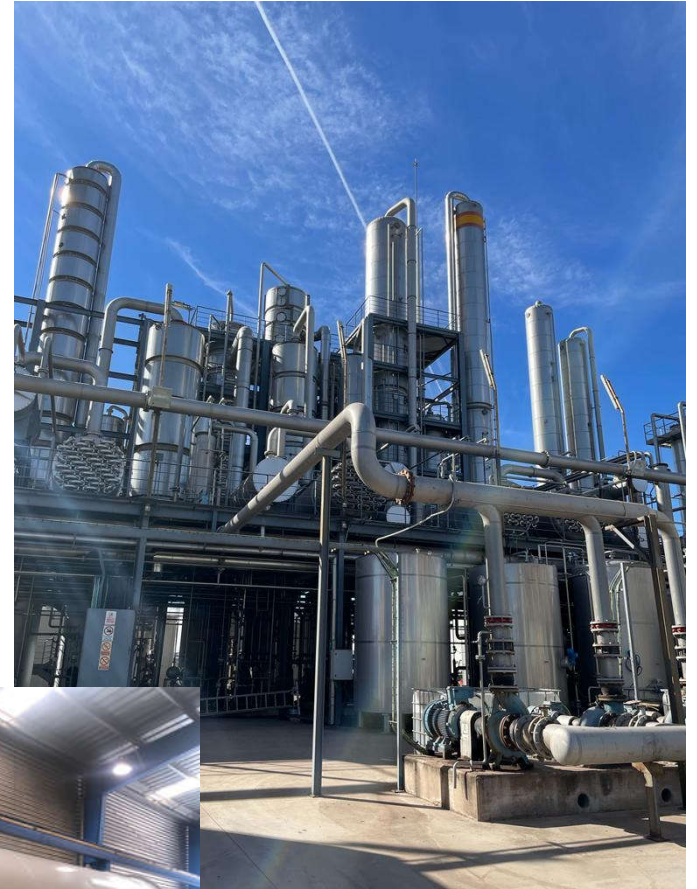

Usinage

Machining

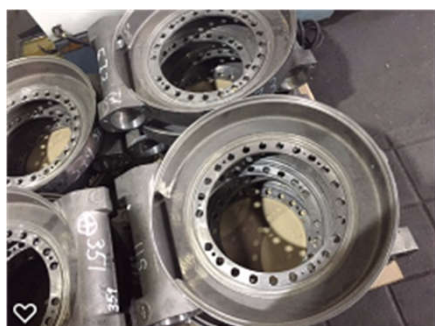

Assemblage - Intégration

Assembly - Integration



Assemblage - Intégration

Assembly - Integration



Charpente - Plateforme

Steel Structure

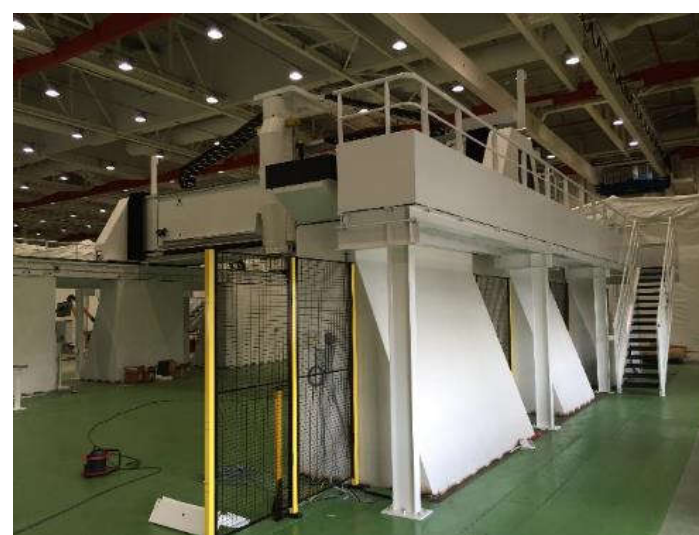

Charpente - Plateforme

Steel Structure



Charpente - Plateforme

Steel Structure



Charpente - Plateforme

Steel Structure



Plateforme

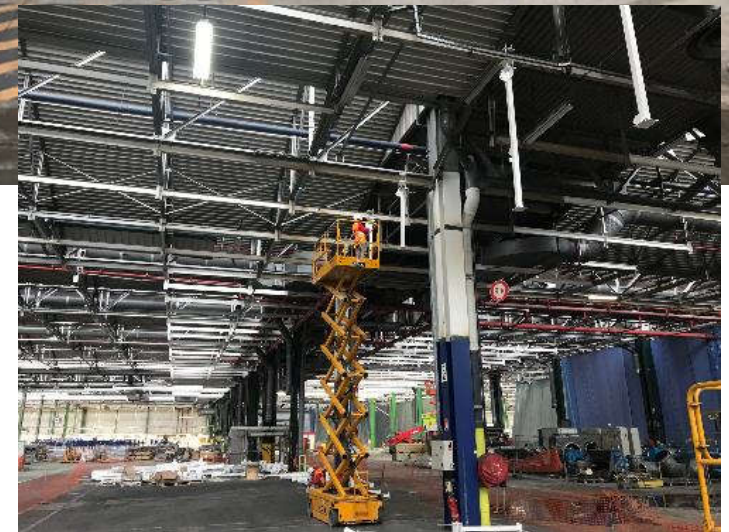
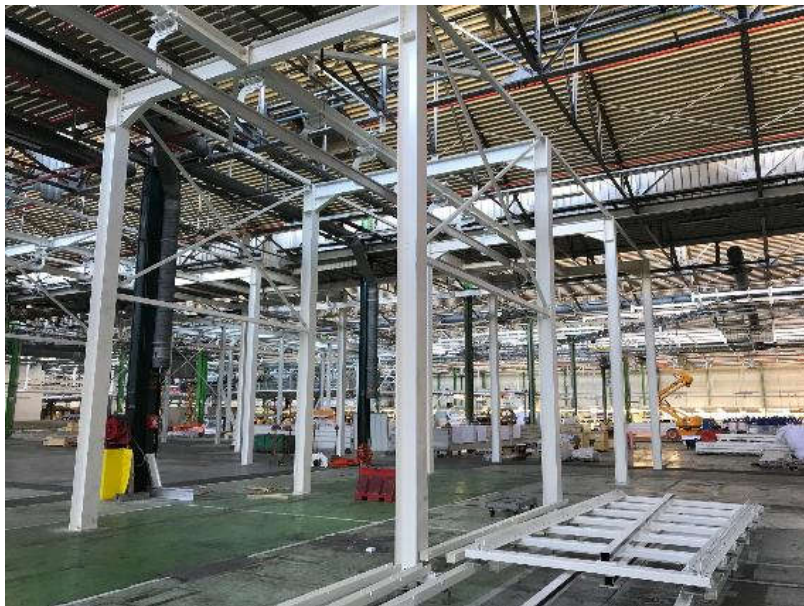
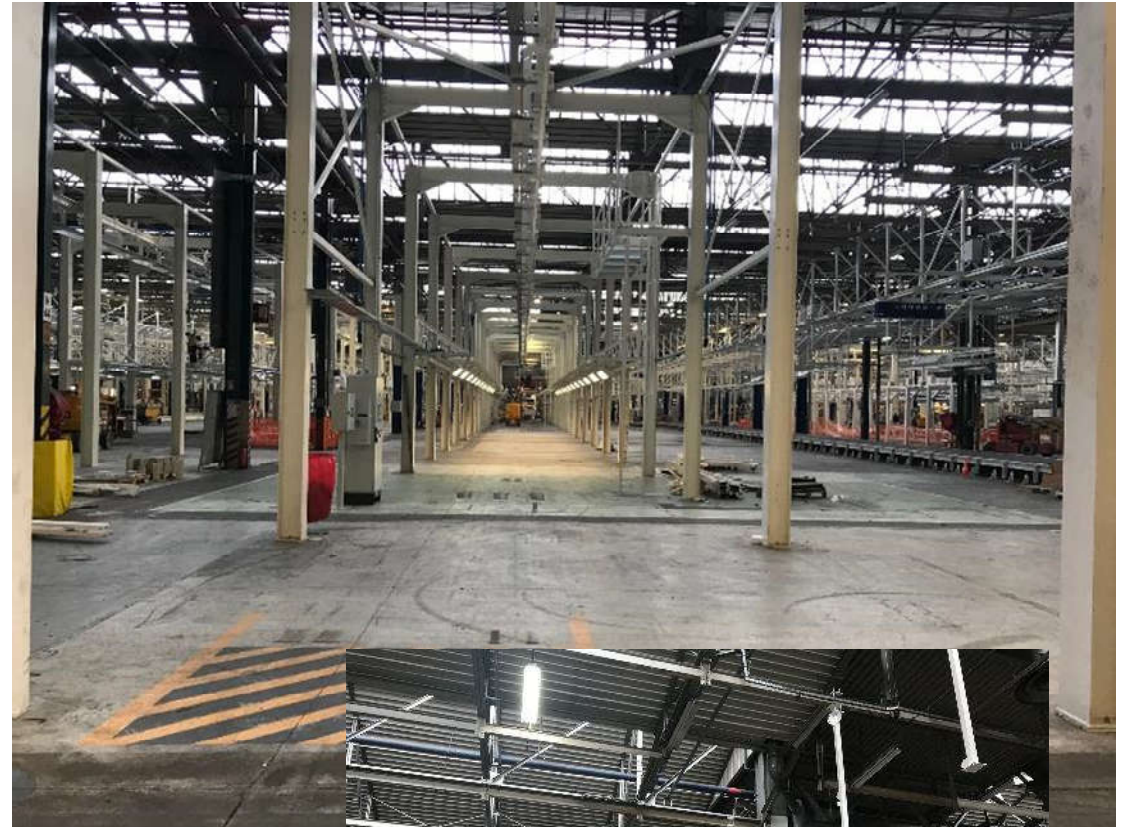
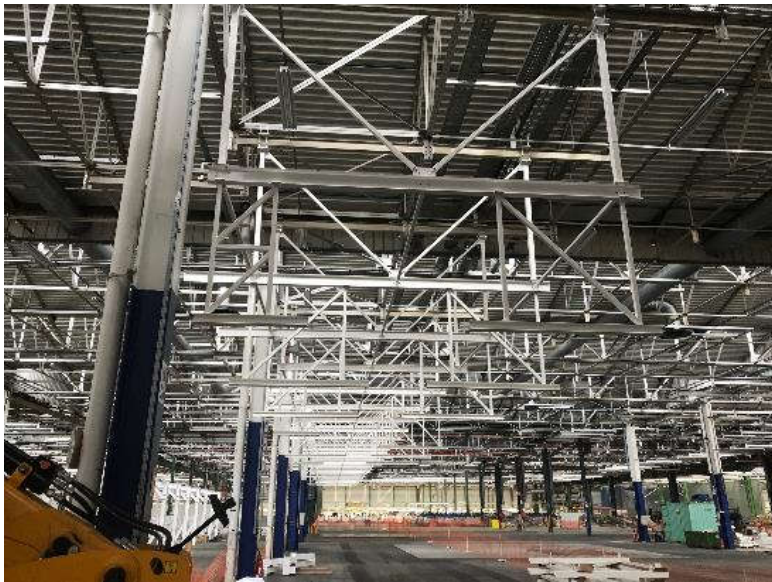

Passerelle



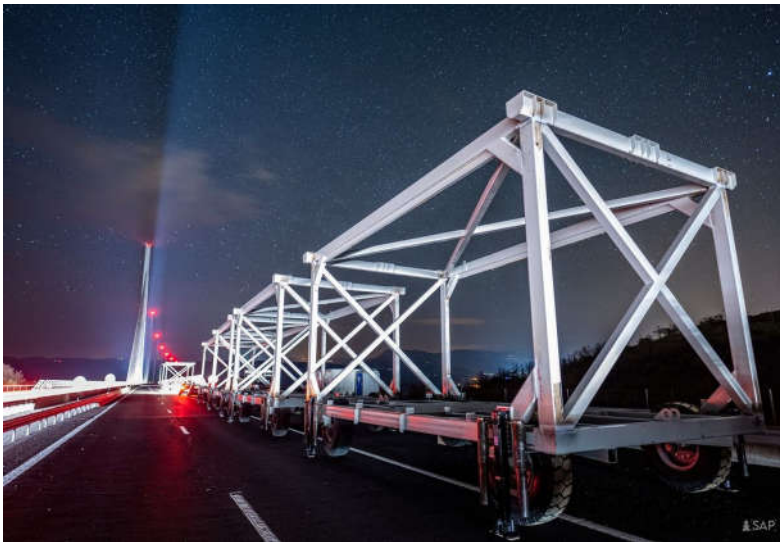



Etudes - Conception

Studies - Conception

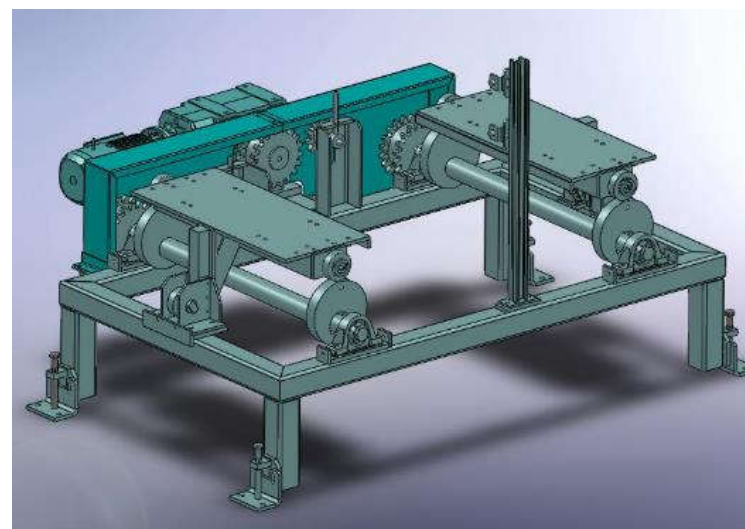
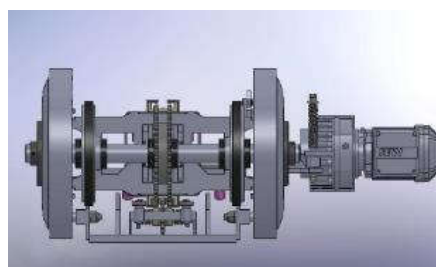
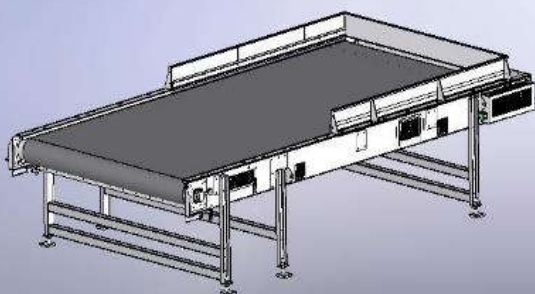
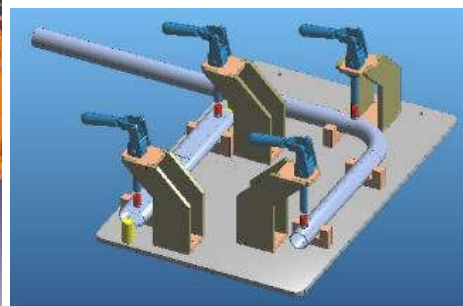
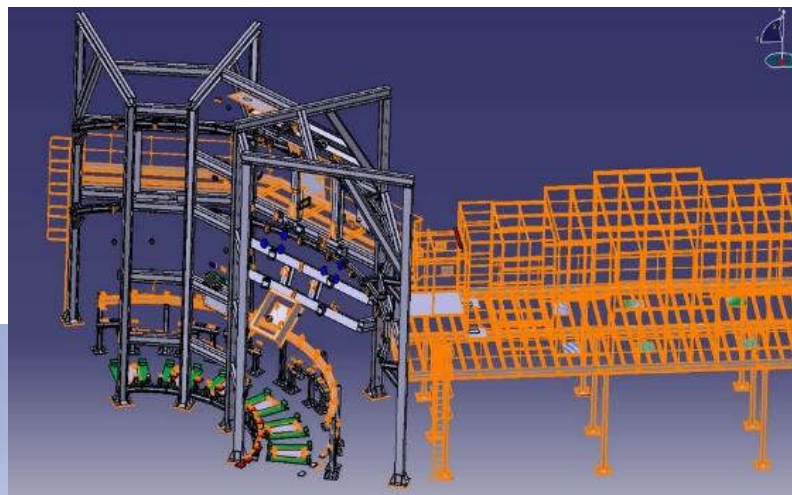

Etudes - Conception

Studies - Conception

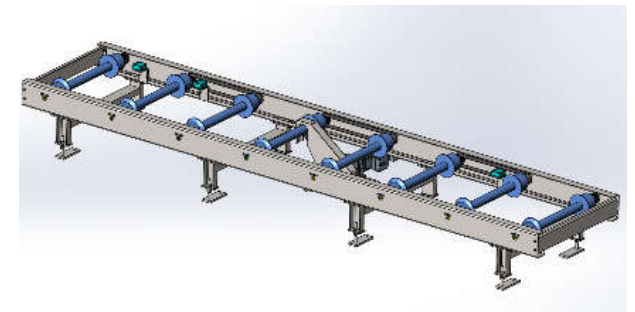
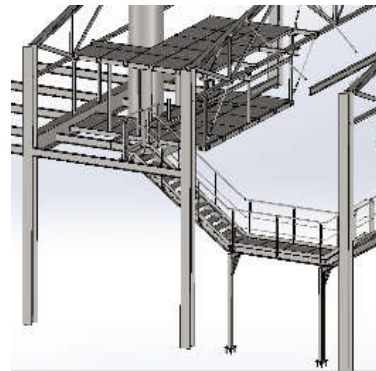
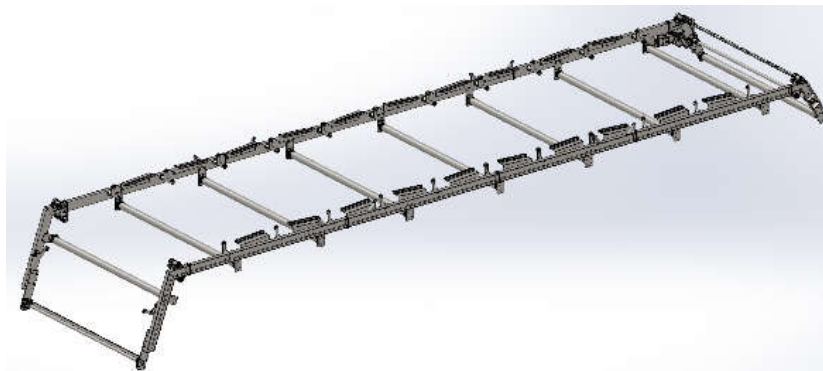
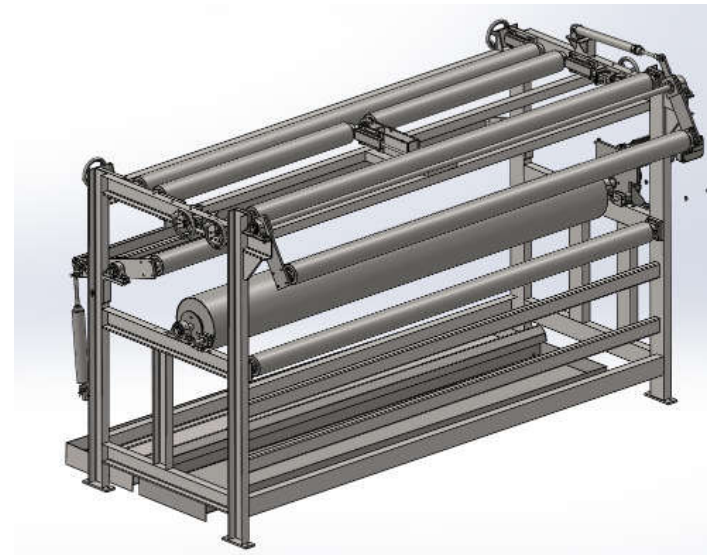
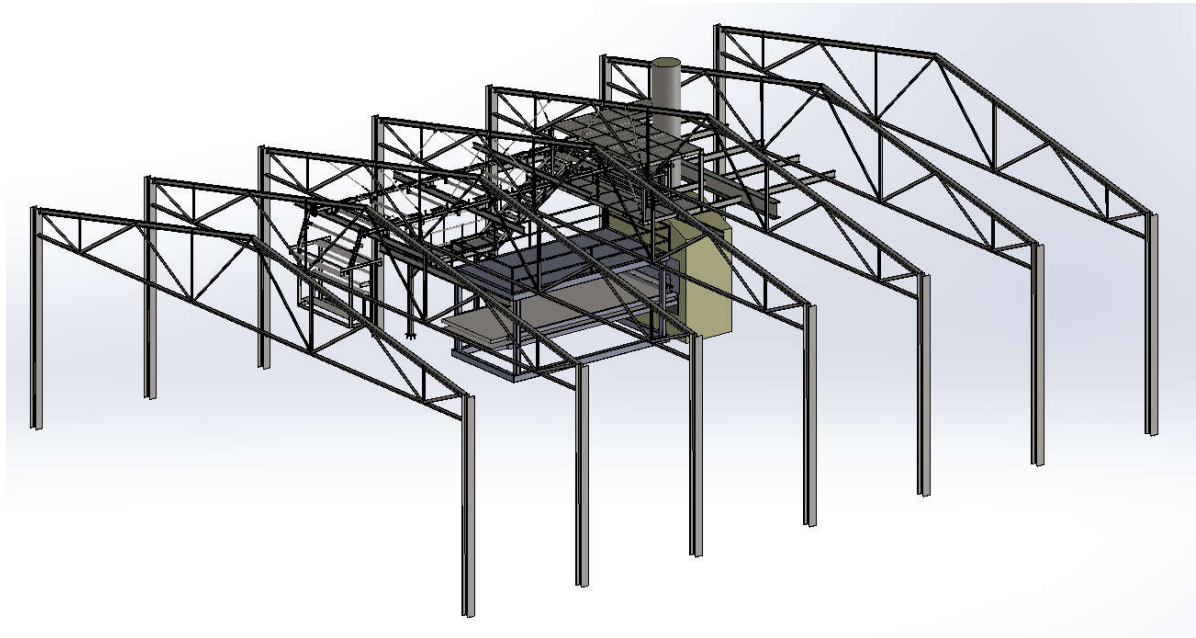

Etudes - Conception

Studies - Conception

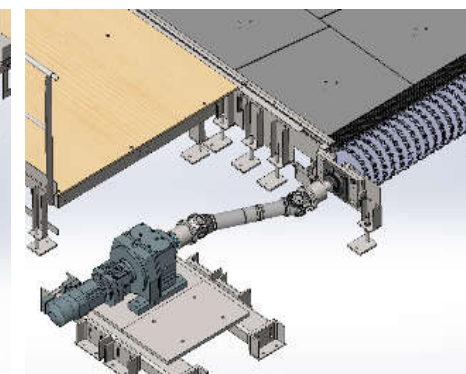
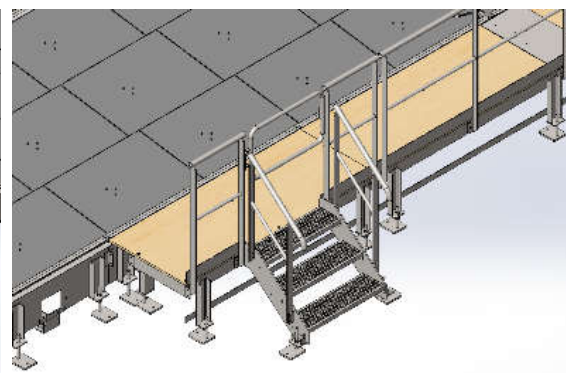
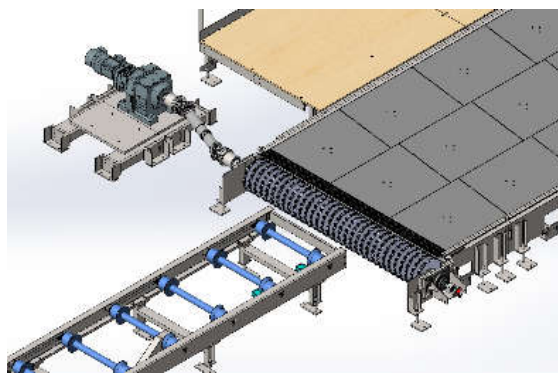
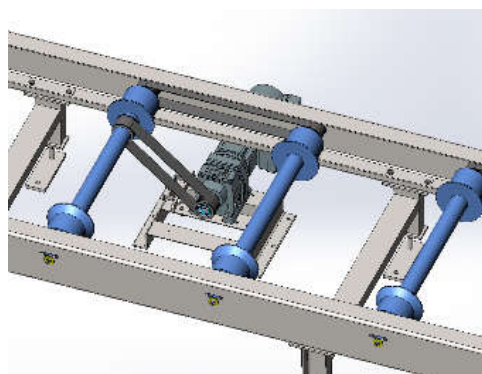
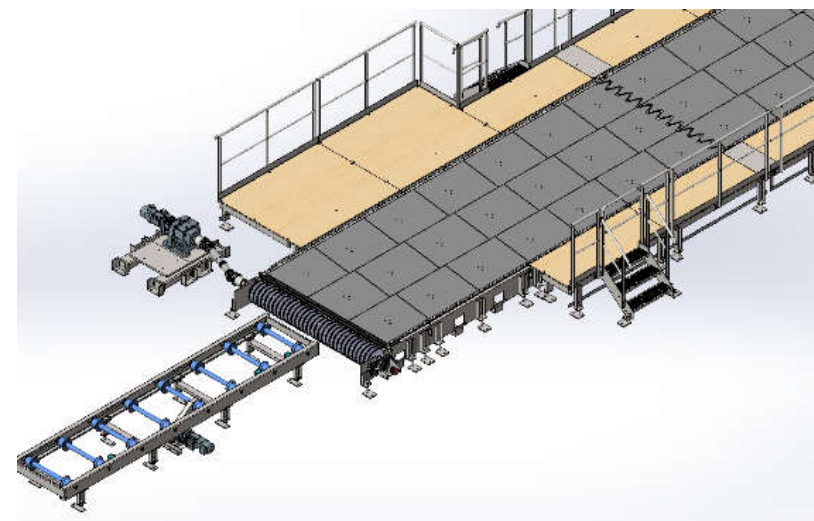
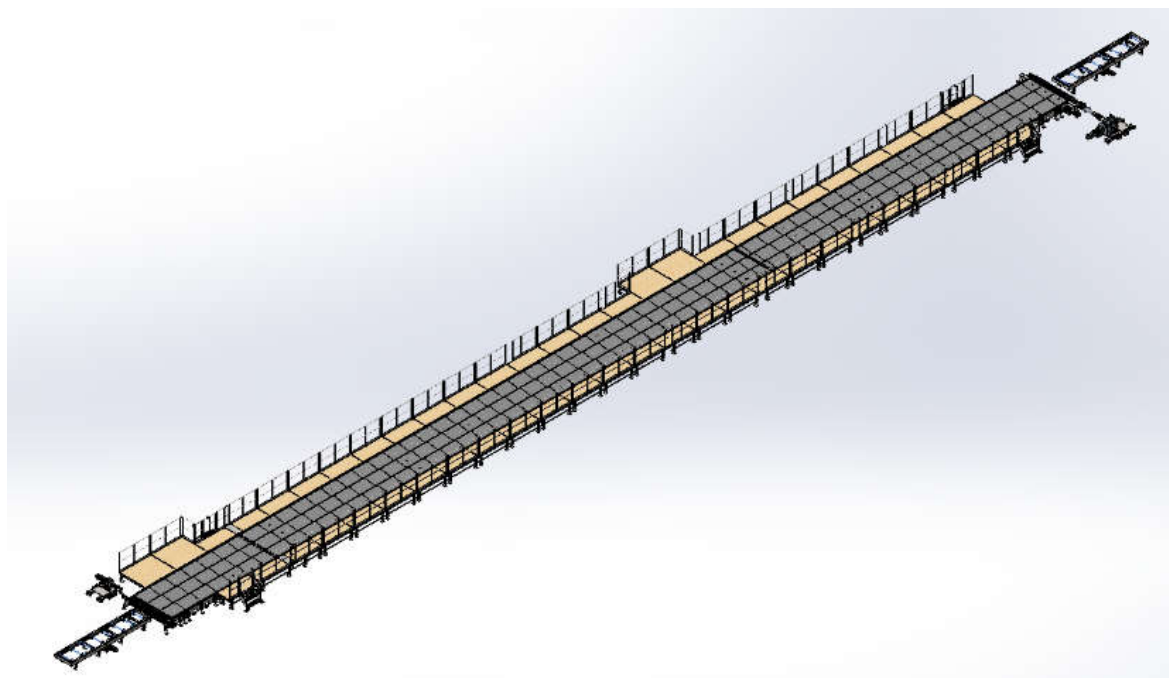

Projet Global : Etude de Faisabilité -> Prototype

Global Project : Feasibility Studies -> Prototype

