

POHLAD Z ULICE

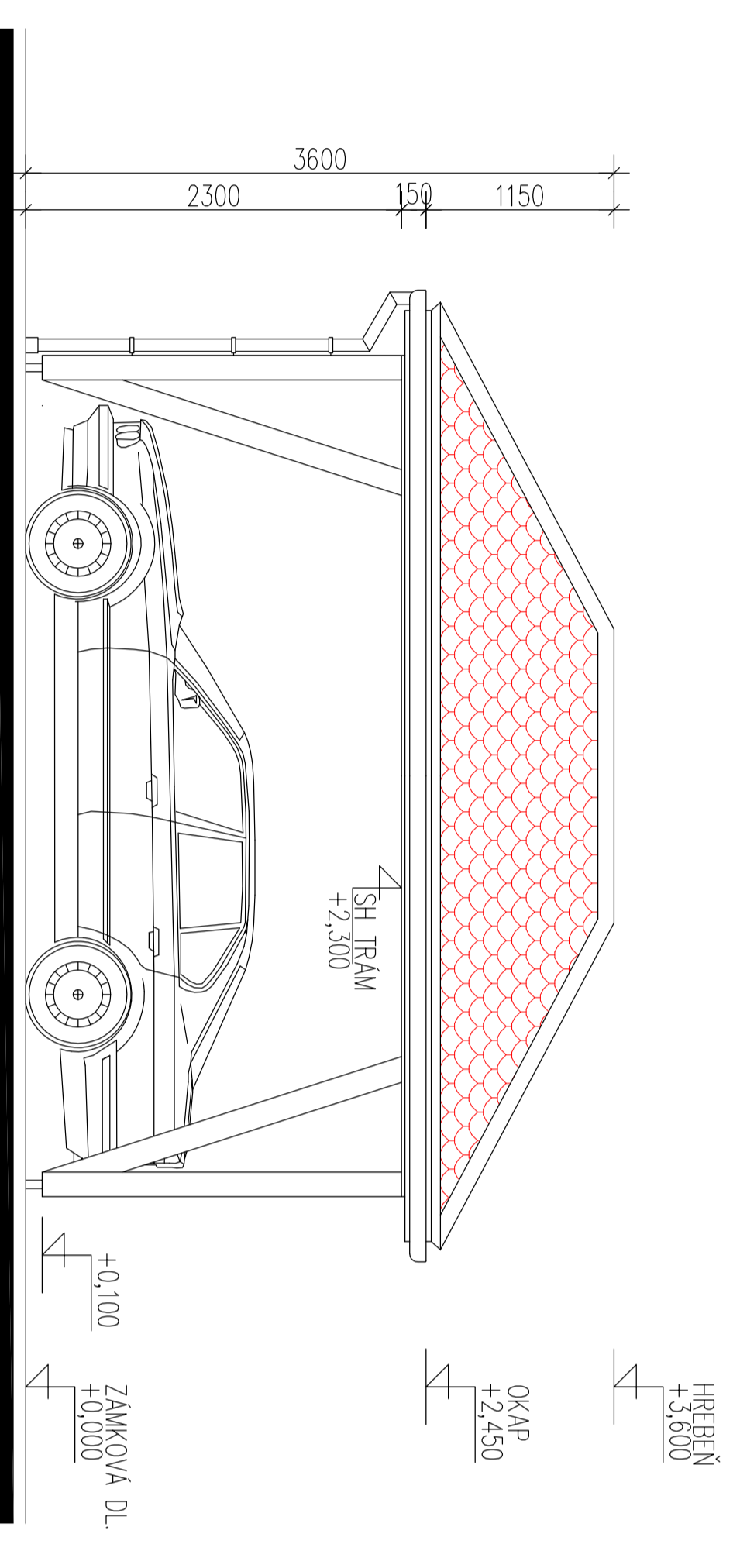

POHLAD OD RODINNÉHO DOMU

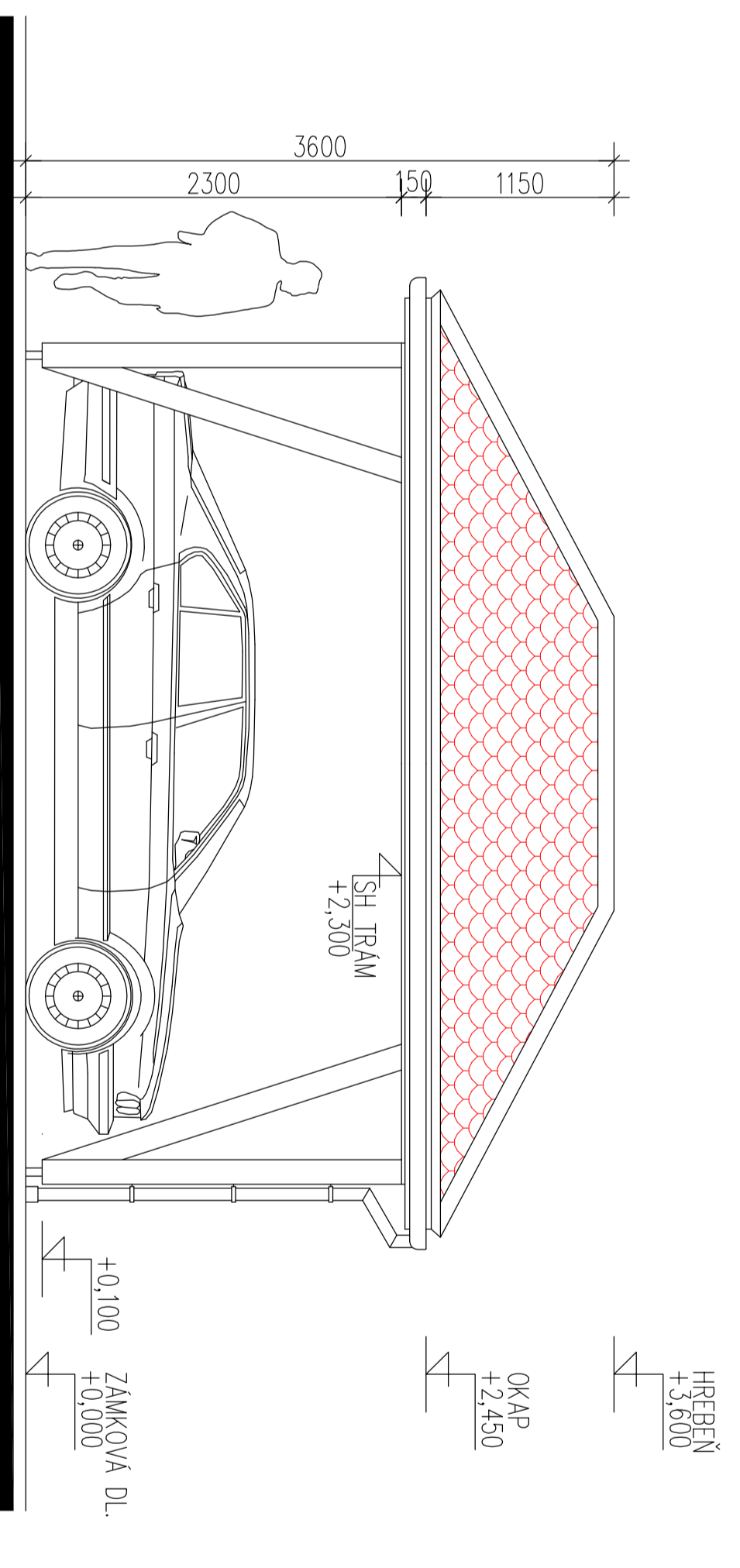

POHLAD OD SUSEDA

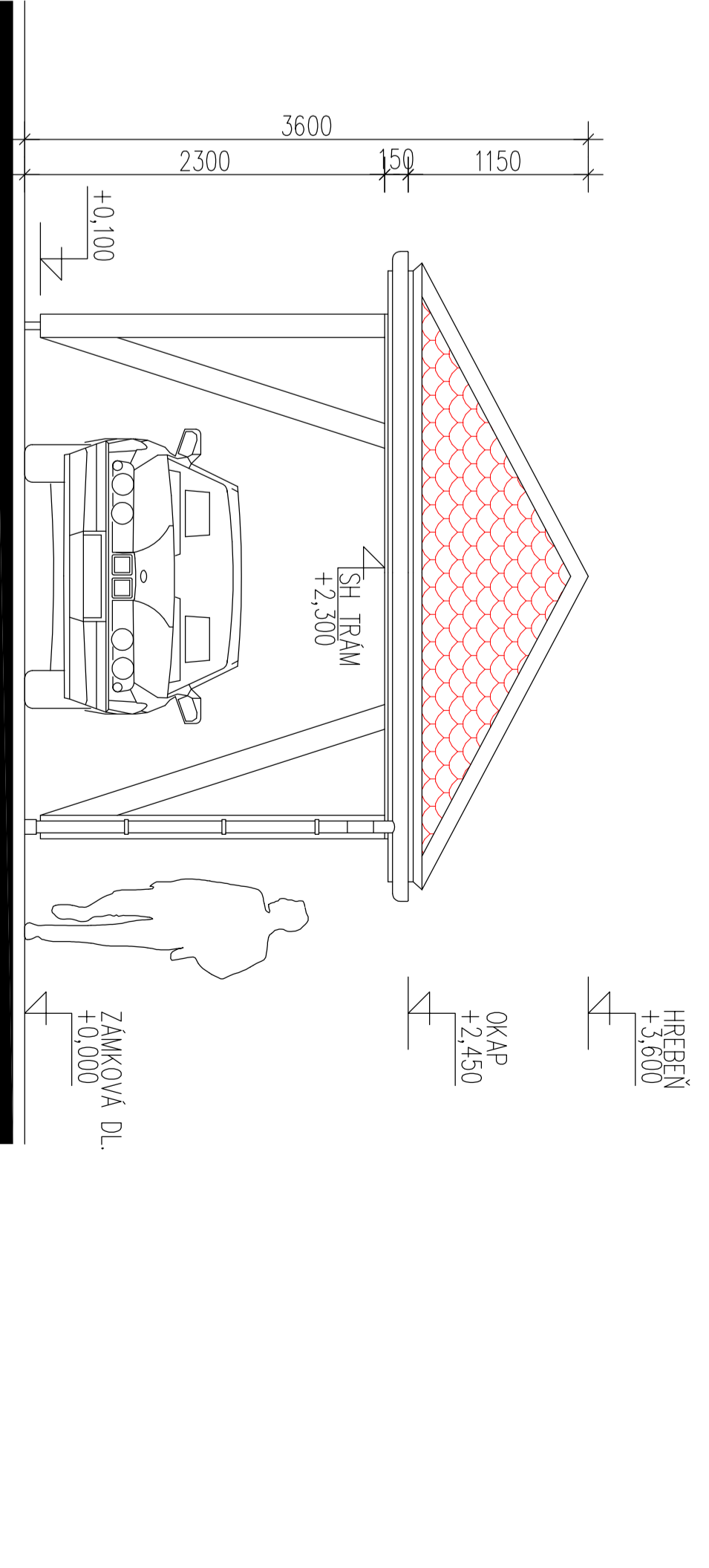

POHLAD ZO ZADU

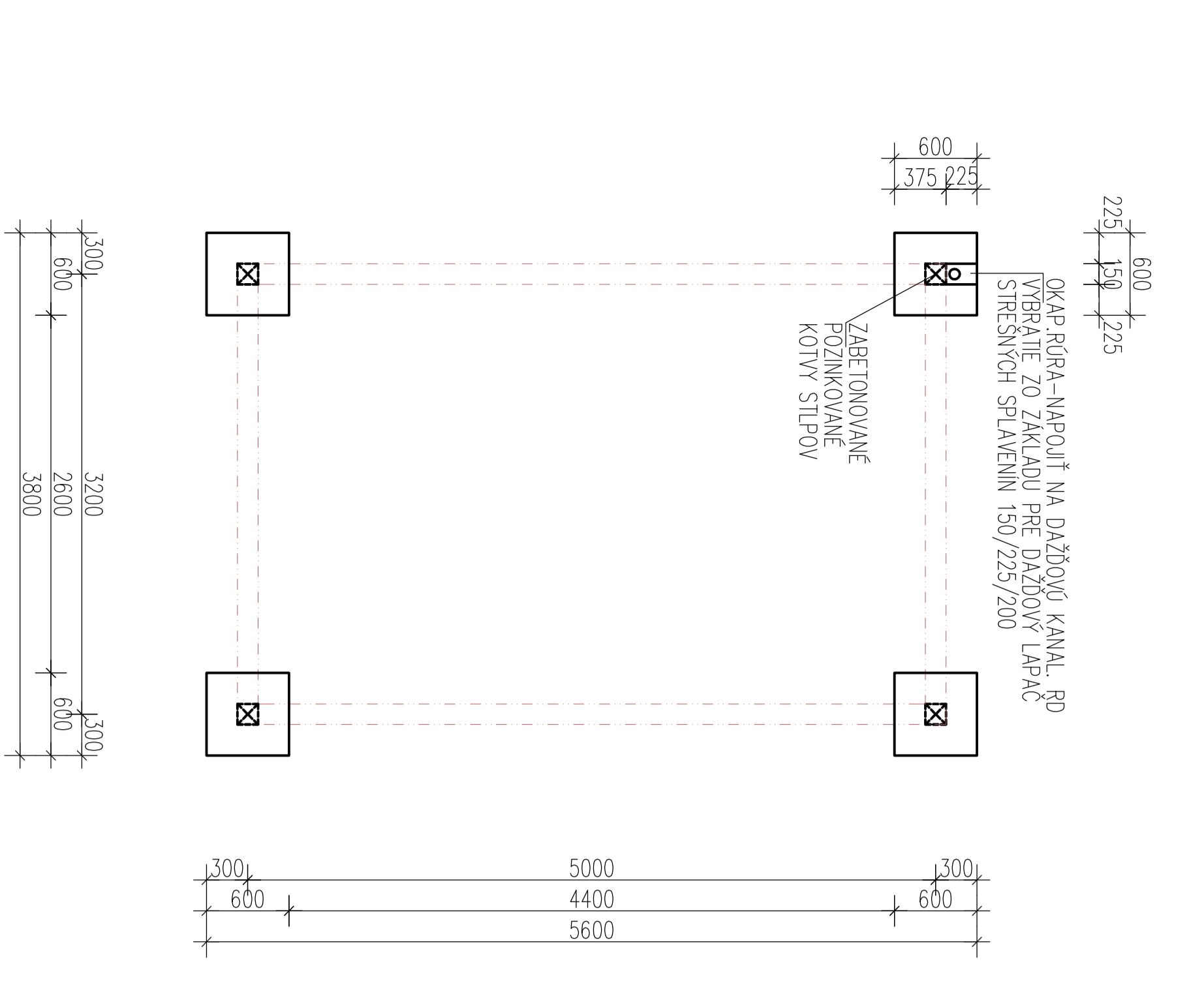

PODORYS ZÁKLADOV

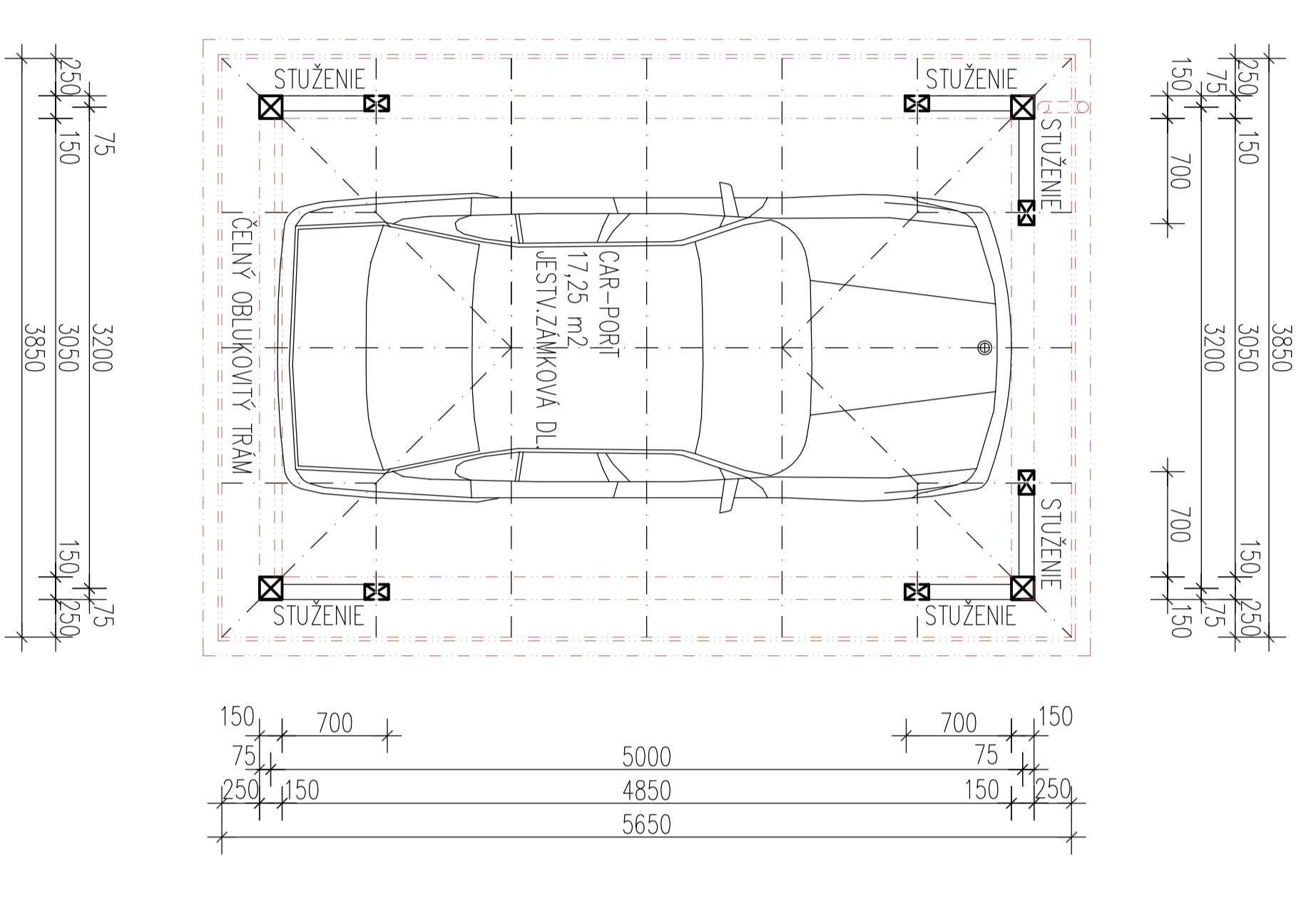

PODORYS

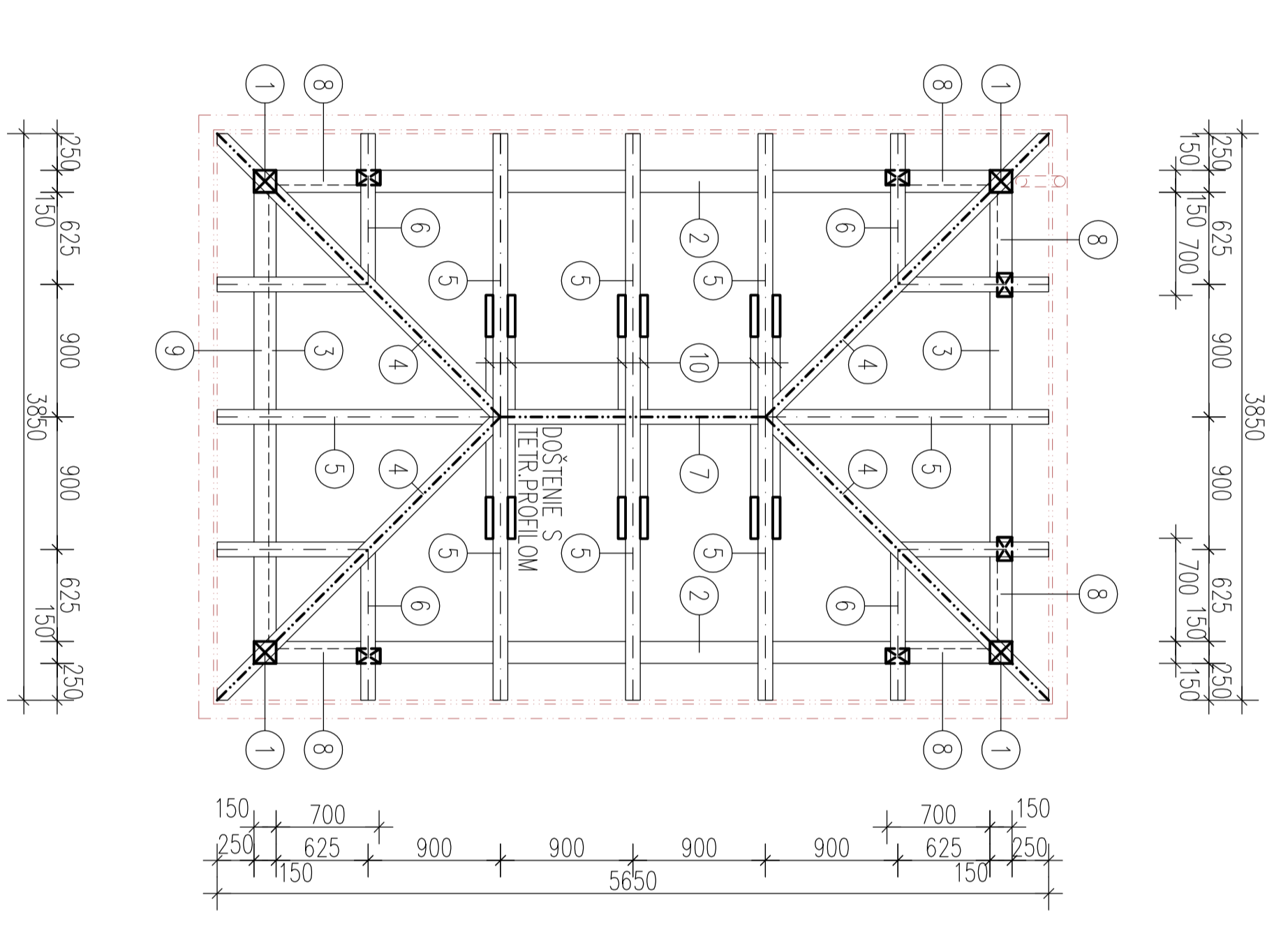

PODORYS KROVU

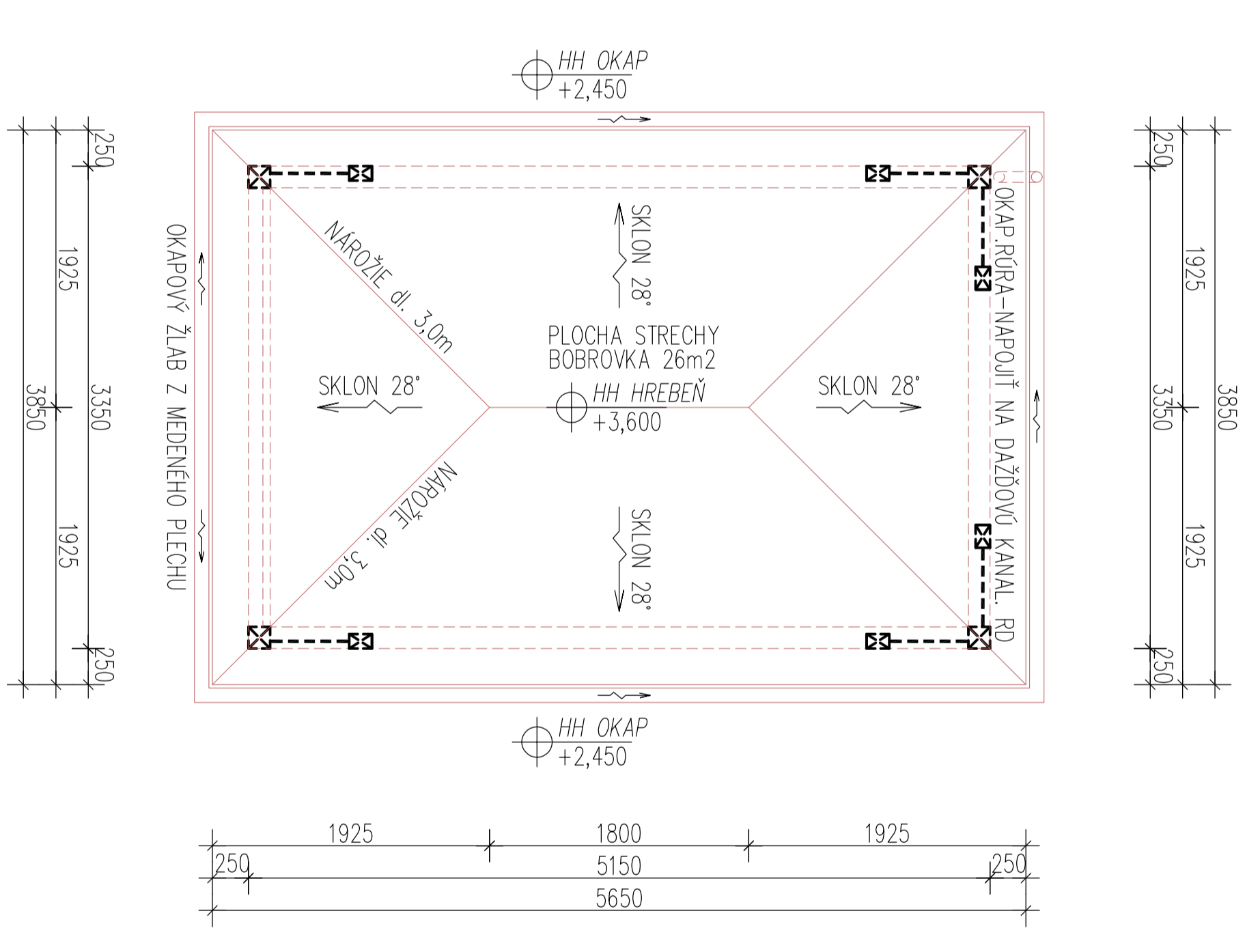

PODORYS STRECHY

- Ⓐ BET ŠKRIPIA A ŽEBROVKA
- LATOVNÉ KONTRALATY 30/50
- HODROZ STREŠNA FOLIA NA DOŠŤNINE
- DOŠŤNINE – TAHANÝ SY PROFIL
- HOB OVANÉ BREVENÉ KONSTRUKCE
- S MÄTEROM VO FÄRBE AKO OVÄNÄ NA DOME
- Ⓑ KESTY ZÄMKOVÄ DLAŽBA
- UPRAVENÄ PODLA ROHREBY

VÝPIS REZIVÄ:

Č. ÚDEL	S (mm)	V (mm)	ÖL. (m)	POČASOVN. M3
1	150	150	2,20	4
2	150	150	5,15	2
3	150	150	3,35	2
4	150	150	3,00	4
5	100	150	2,25	8
6	100	150	1,25	8
7	100	150	1,80	1
8	150	150	2,35	6
9	100	150	3,15	4
10	50	150	1,65	6

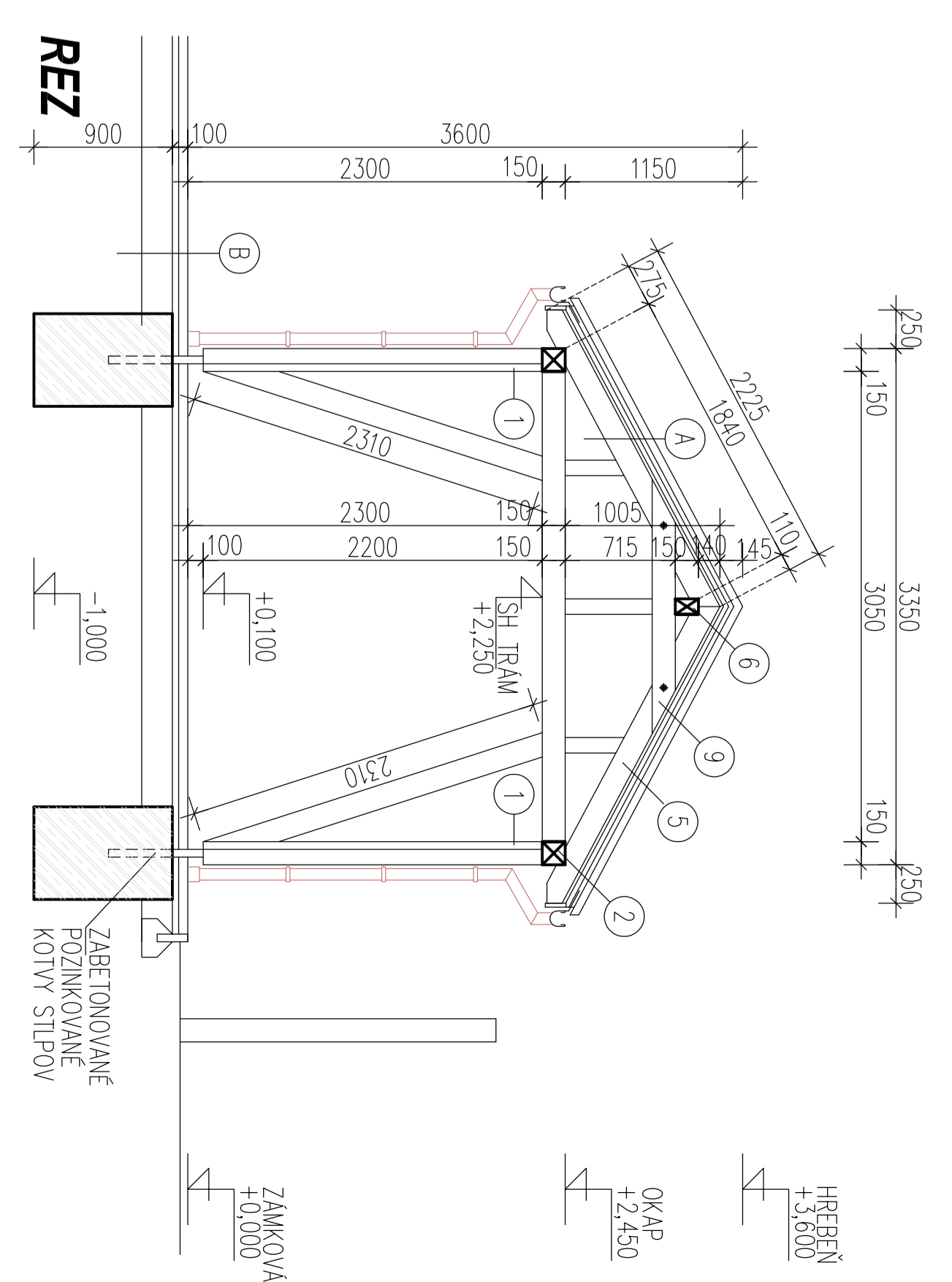

CAR-PORT K RODINNÉMU DOMU
 OSO PÄRČIA X: 21/4/6, 2822/12

ARCHITEKTURA **PODORYSY, POHLADY, REZY**

INVESTOR: ING. NICHÄL HÄMREK, DUNAJSKÄ STREDA
 OSGÄL VÝKRESU: STUPEŇ: FS
 FORMÄT ÄÄ: B ÄÄ
 DÄTUM: 02/2010

SEVERÄKA

2