

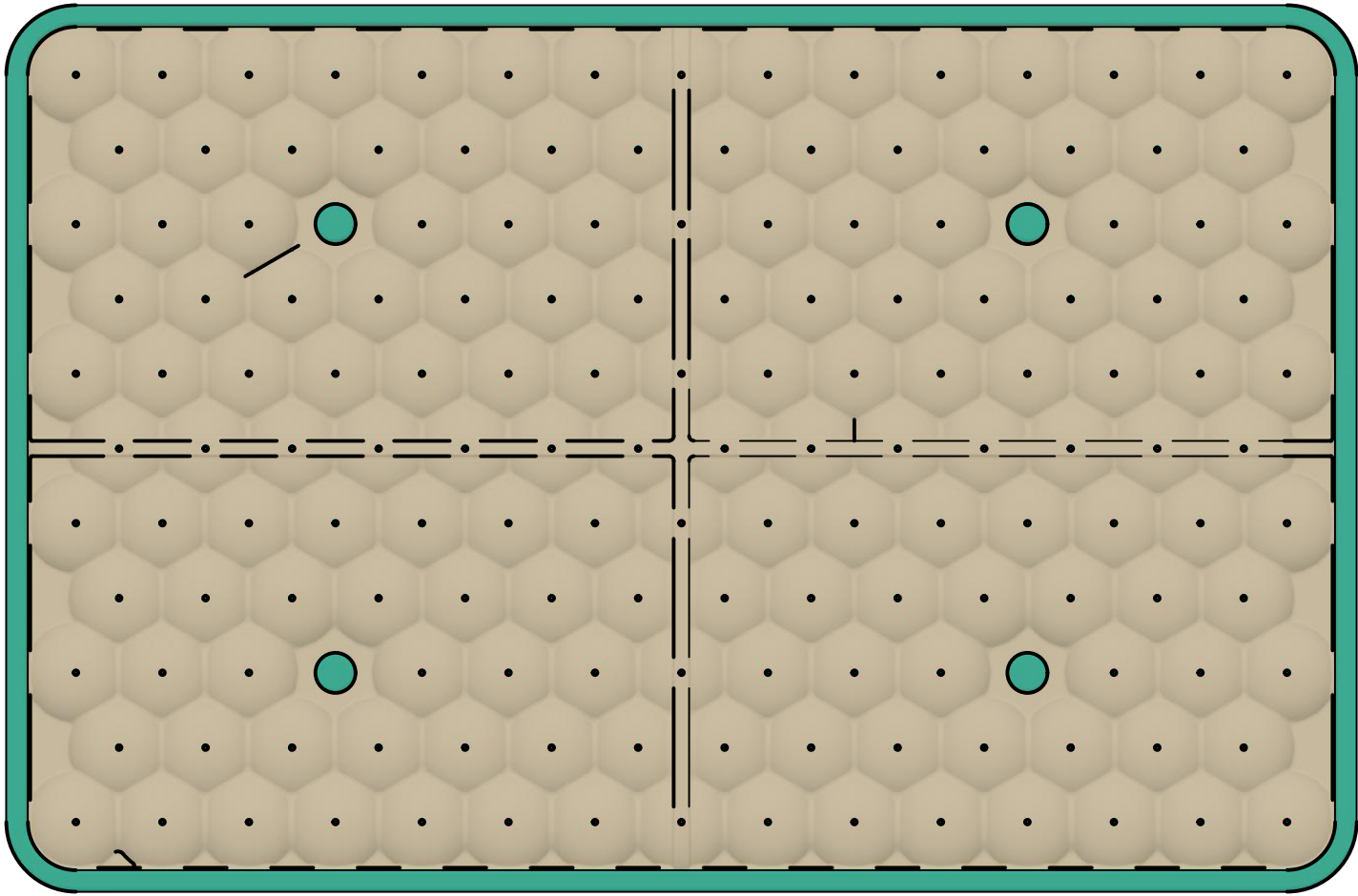

A-A (1:1.5)



Parts List				
Item	Qty	Part Number	Description	Material
1	1	11.11.01	5/8 Sphere Bottom	Rubber, Silicone 50 shore A
2	1	11.11.02	5/8 Sphere Top1	Rubber, Silicone 50 shore A

Dept.	Technical reference	Created by <b>Lukas Kastner 09/04/2020</b>	Approved by
 <small>All rights reserved: These drawings of the concepts, design, and ideas which they incorporate remain the property of Crucial Detail. They may not be copied, reproduced, disclosed to others or used in connection with any work other than the specified project for which they were prepared, in whole or in part, without the prior written authorization of Crucial Detail.</small>		Document type	Document status
		Title <b>11.11.00 AICE 5/8 Sphere QT</b>	
		Rev.	Date of issue
		Sheet <b>1/3</b>	

# B-B (1:1.5)

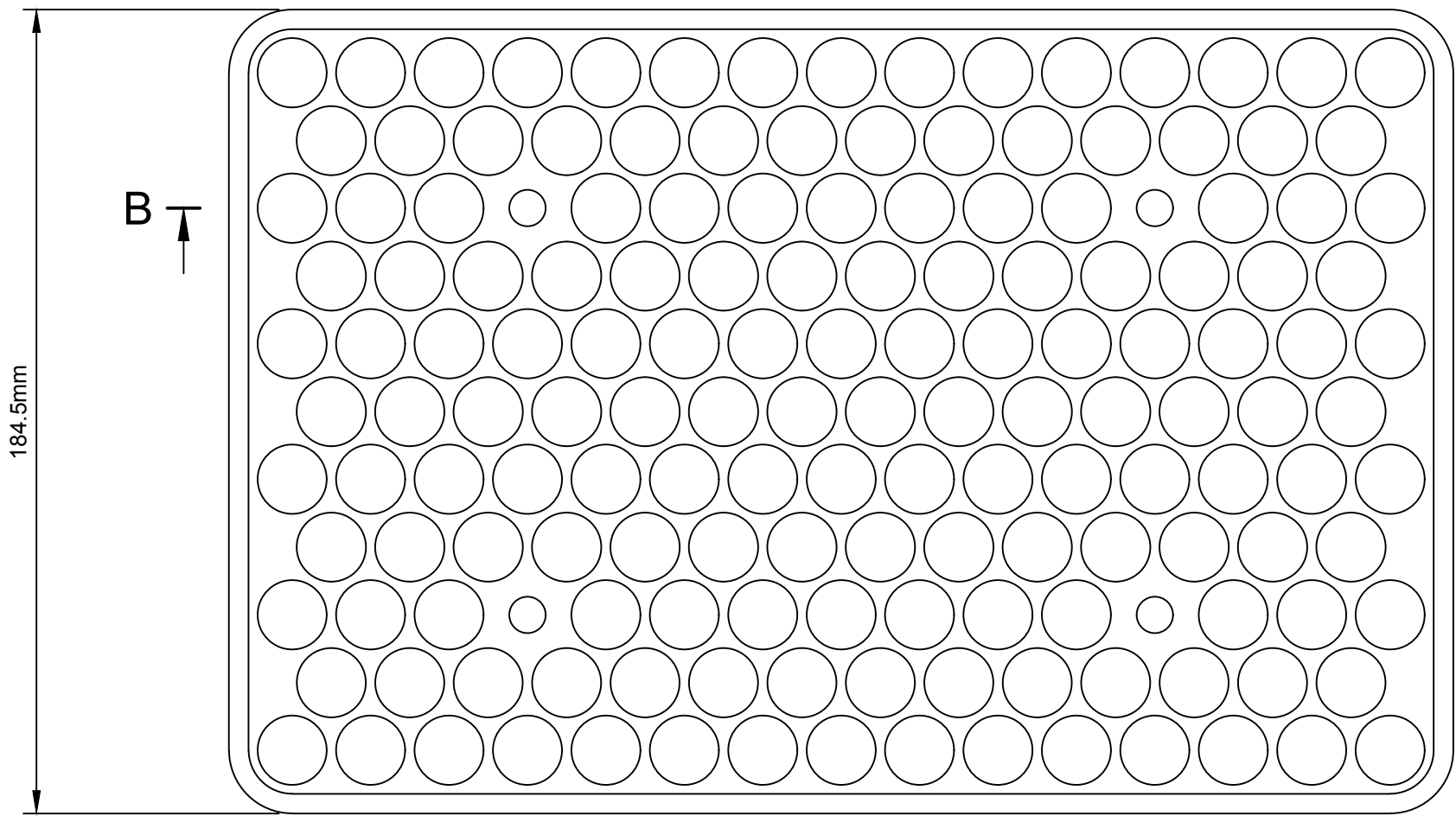
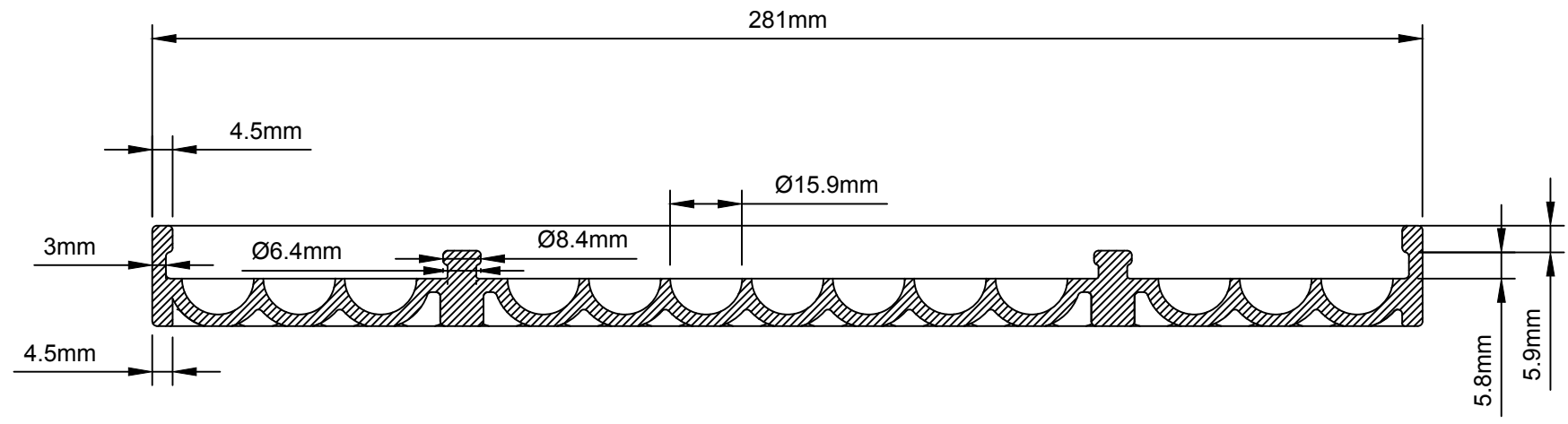

Dept.	Technical reference	Created by <b>Lukas Kastner 09/04/2020</b>	Approved by
 <small>All rights reserved: These drawings of the concepts, design, and ideas which they incorporate remain the property of Crucial Detail. They may not be copied, reproduced, disclosed to others or used in connection with any work other than the specified project for which they were prepared, in whole or in part, without the prior written authorization of Crucial Detail.</small>		Document type	Document status
		Title <b>11.11.01 AICE 5/8 Sphere QT BOTTOM</b>	
		Rev.	Date of issue
		Sheet <b>2/3</b>	

C-C (1:1.5)

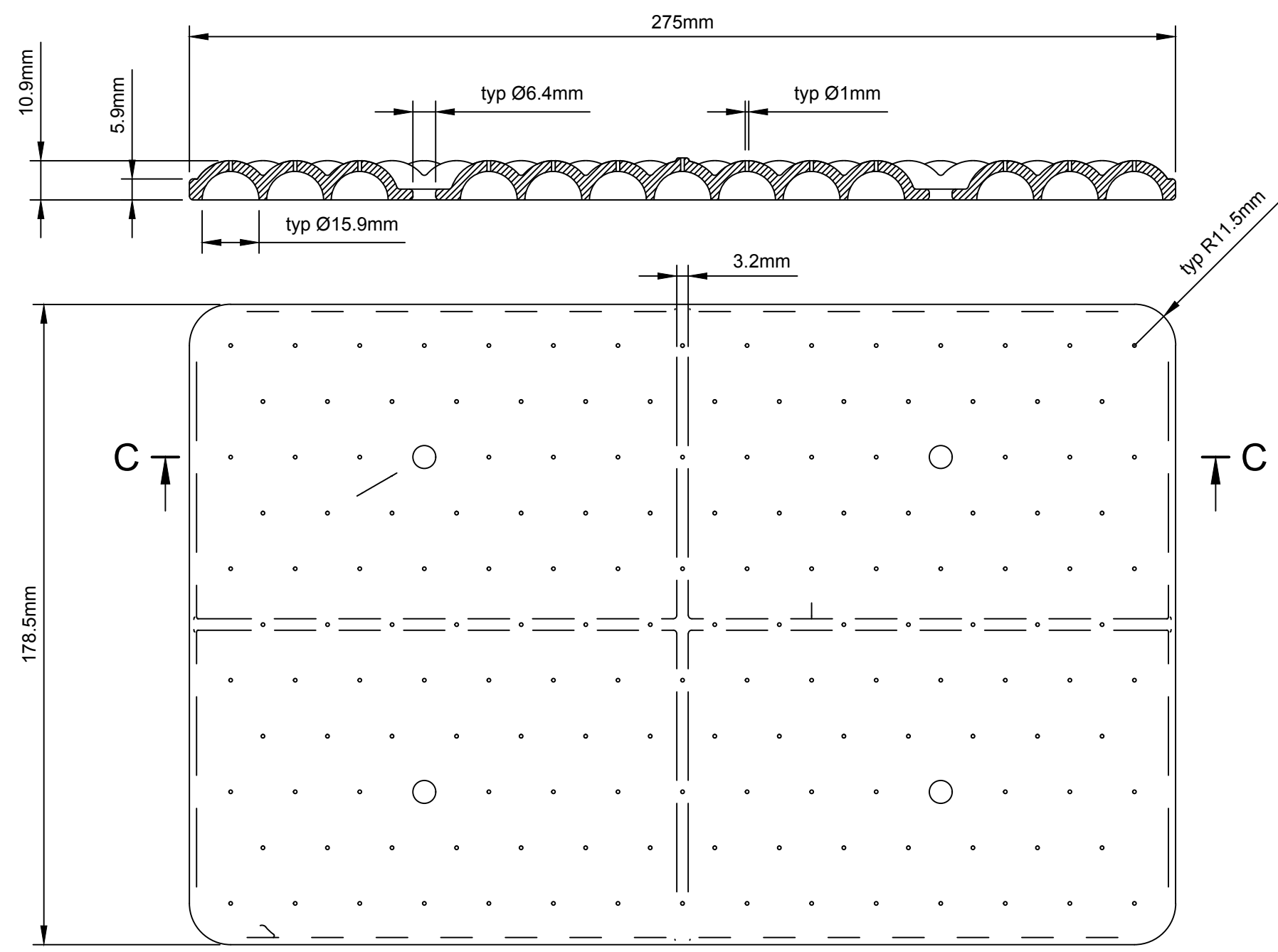

Dept.	Technical reference	Created by <b>Lukas Kastner 09/04/2020</b>	Approved by
 <small>All rights reserved: These drawings of the concepts, design, and ideas which they incorporate remain the property of Crucial Detail. They may not be copied, reproduced, disclosed to others or used in connection with any work other than the specified project for which they were prepared, in whole or in part, without the prior written authorization of Crucial Detail.</small>	Document type	Document status	
	Title <b>11.11.02 AICE 5/8 Sphere QT TOP</b>	DWG No.	
	Rev.	Date of issue	Sheet <b>3/3</b>