

Air to Water Heat Pump AX-09

INSTALLATION MANUAL

For safe and correct use, read this manual as well as the indoor unit installation manual thoroughly before installing the unit.

FOR INSTALLER

English

Contents

1. Safety precautions	2	5. Water piping work	5
2. Installation location	3	6. Electrical work	5
3. Installation procedures	4	7. Test run	6
4. Drainage piping work	5		

1. Safety precautions

▶ Before installing the unit, make sure you read all the "Safety precautions".

⚠ Warning:

Precautions that must be observed to prevent injuries or death.

⚠ Caution:

Precautions that must be observed to prevent damages to the unit.

After installation, perform the test run to ensure normal operation. Then explain your customer the "Safety Precautions," use, and maintenance of the unit based on the information in the Operation Manual. Both the Installation Manual and the Operation Manual must be given to the user. These manuals must always be kept by the actual users.

⚡ : Indicates a part which must be grounded.

⚠ Warning:

Carefully read the labels attached to the unit.

⚠ Warning:

- The unit must not be installed by the user. Ask an installer or an authorized technician to install the unit. If the unit is installed improperly, water leakage, electric shock, or fire may be caused.
- The unit must be installed according to the instructions in order to minimize the risk of damages by earthquakes, typhoons, or strong winds. Improperly installed unit may fall down and cause damages or injuries.
- The unit must be securely installed on a structure that can sustain its weight. If the unit is mounted on an unstable structure, it may fall down and cause damages or injuries.
- If the air to water heat pump is installed in an enclosed area, measures must be taken to prevent the refrigerant concentration in the room in the event of refrigerant leakage. Consult an installer regarding the appropriate measures. Should the refrigerant leak and cause the concentration oxygen in the room may lack.
- Ventilate the room if refrigerant leaks during operation. If refrigerant comes into contact with a flame, poisonous gases will be released.
- All electric work must be performed by a qualified technician according to local regulations and the instructions given in this manual. The units must be powered by dedicated power lines and the correct voltage and circuit breakers must be used. Power lines with insufficient capacity or incorrect electrical work may result in electric shock or fire.
- Only the specified cables can be used for wiring. Connections must be made securely without tension on the terminals. If cables are connected or installed improperly, it may result in overheating or fire.
- Terminal block cover panel of the outdoor unit must be firmly fixed. If the cover panel is mounted improperly, dust and moisture may enter the unit, and it may cause electric shock or fire.

- When installing or moving the air to water heat pump, make sure to use the specified refrigerant (R410A) to charge the refrigerant lines. Do not either mix it with any other refrigerant or allow air to remain within the pipes. Air enclosed in the pipes can cause pressure peaks resulting in a rupture and other hazards.
- Make sure to use accessories authorized by Mitsubishi Electric and ask an installer or an authorized technician to install them. If accessories are improperly installed, it may cause water leakage, electric shock, or fire.
- Do not remodel the unit. Consult an installer for repairs. If alterations or repairs are not performed correctly, it may cause water leakage, electric shock, or fire.
- The user should never attempt to repair the unit or transfer it to another location. If the unit is installed improperly, it may cause water leakage, electric shock, or fire. If the air to water heat pump needs to be repaired or moved, ask an installer or an authorized technician.
- After installation has been completed, make sure that refrigerant does not leak. If refrigerant leaks into the room and comes into contact with the flame of a heater or portable cooking range, poisonous gases will be released.
- Use clean enough water which meets water quality standards. The deterioration of water quality may result in the system breakdown or the water leakage.
- Never use anything other than water as a medium. It may cause a fire or an explosion.
- Do not use heated or cooled water that is produced by the air to water heat pump directly for drinking or cooking. There is a risk to damage your health. There is also a risk that installing the water heat exchanger may corrode if the necessary water quality for the air to water heat pump system cannot be maintained. If you wish to use the heated or cooled water from the heat pump for these purposes, take measure such as to the second heat exchanger within the water piping system.

1.1. Before installation

⚠ Caution:

- Do not use the unit in an unusual environment. If the air to water heat pump is installed exposed to steam, volatile oil (including machine oil), or sulfuric gas, or exposed to briny air, or covered with snow, the performance can be significantly reduced and the internal parts can be damaged.
- Do not install the unit where combustible gases may leak, be produced, flow, or accumulate. If combustible gas accumulates around the unit, it may cause fire or explosion.
- The outdoor unit produces condensate during the heating operation. Make sure to provide drainage around the outdoor unit if such condensate is likely to cause damage.

- When installing the unit in a hospital or in a building where communication equipments are installed, you may need to take measures to noise and electronic interference. Inverters, home appliances, high-frequency medical equipment, and radio communications equipment can cause the air to water heat pump to malfunction or to breakdown. At the same time, the noise and electronic interference from the air to water heat pump unit may disturb the proper operation of medical equipment, and communications equipment.

1.2. Before installation (relocation)

⚠ Caution:

- Be fully careful when moving the units. The unit must be carried by at least 2 people, as it weighs 20 kg or more. Do not hold the packaging bands. Wear protective gloves to unpack and to move it, in order to avoid your hands be injured by fins or other parts.
- Be sure to safely dispose of the packaging materials. Packaging materials, such as nails and other metal or wooden parts may cause injuries.

- The base of the outdoor unit must be periodically checked to ensure not being loose, cracked or damaged. If such defects are left untreated, the unit may fall down and cause damage or injuries.
- Do not wash the air to water heat pump unit. You may receive an electric shock.

1. Safety precautions

1.3. Before electric work

⚠ Caution:

- Be sure to install a circuit breaker. If it is not installed, there may be a risk to get an electric shock.
- For the power lines, use standard cables of sufficient capacity. Otherwise, it may cause a short circuit, overheating, or fire.
- When installing the power lines, do not apply tension to the cables. The cables may be cut or overheated resulting in a fire.

- Make sure to ground the unit. Do not connect the ground wire to gas or water pipes, lightning rods, or telephone grounding lines. If the unit is not properly grounded, there may be a risk to get an electric shock.
- Make sure to use circuit breakers (ground fault interrupter, isolating switch (+B fuse), and molded case circuit breaker) with the specified capacity. If the circuit breaker capacity is larger than the specified capacity, breakdown or fire may result.

1.4. Before starting the test run

⚠ Caution:

- Turn on the main power switch more than 12 hours before starting operation. Starting operation immediately after turning on the power switch can severely damage the internal parts. Keep the main power switch turned on during the operating period.
- Before starting operation, check that all panels, guards and other protective parts are correctly installed. Make sure not to get injured by touching rotating, hot, or high voltage parts.

- Do not touch any switch with wet hands. There may be a risk to get an electric shock.
- Do not touch the refrigerant pipes with bare hands while unit is running. The refrigerant pipes can be hot or cold depending on the condition of the flowing refrigerant. There may be a risk to get burn or frostbite.
- After stopping operation, make sure to wait at least five minutes before turning off the main power. Otherwise, it may cause water leakage or breakdown.

1.5. Using R410A refrigerant air to water heat pump

⚠ Caution:

- Use only R410A refrigerant. If another refrigerant is used, the chlorine will let the oil deteriorate.
- Use the following tools specifically designed for R410A refrigerant use. Contact your nearest installer for further details.

- Be sure to use the proper tools. If dust, debris, or moisture enters the refrigerant pipes, the refrigeration oil may deteriorate.
- Do not use a charging cylinder. If a charging cylinder is used, the composition of the refrigerant may change and the efficiency will be worsened.

Tools (for R410A)	
Gauge manifold	Charge hose
Gas leak detector	Vacuum pump adapter
Torque wrench	Electronic refrigerant charging scale

2. Installation location

(mm)

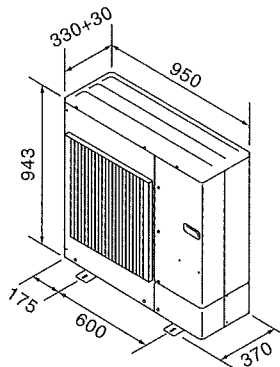

Fig. 2-1

2.1. Choosing the outdoor unit installation location

- Avoid locations where the unit is exposed to direct sunlight or other sources of heat.
- Select a location where noise emitted by the unit does not disturb neighbors.
- Select a location where easy wiring and pipe access to the power source is available.
- Avoid locations where combustible gases may leak, be produced, flow, or accumulate.
- Note that condensate water may be produced by the unit during operation.
- Select a level location that can bear the weight and vibration of the unit.
- Avoid locations where the unit can be covered with snow. In areas where heavy snow fall is anticipated, special precautions must be taken to prevent the snow from blocking the air intake such as to install the unit at higher position or installing a hood on the air intake. This can reduce the airflow and the unit may not operate properly.
- Avoid locations where the unit is exposed to oil, steam, or sulfuric gas.
- Make sure to hold the handles to transport the unit. Do not hold the base of the unit, as there is a risk that hands or fingers may be pinched.

2.2. Outline dimensions (Outdoor unit) (Fig. 2-1)

2. Installation location

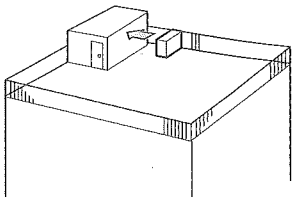

Fig. 2-2

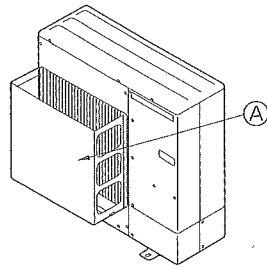

Fig. 2-3

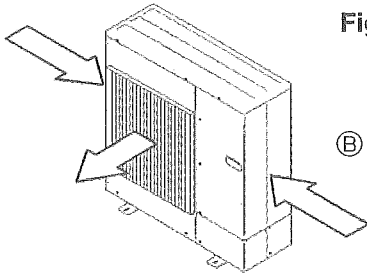

Fig. 2-4

2.3. Windy location installation

When installing the outdoor unit on a rooftop or other location where the unit is exposed to strong wind, do not face the air outlet of the unit directly winds. Strong wind entering the air outlet may impede the normal airflow and it may result in a malfunction.

The following shows three examples of precautions against strong winds.

- ① Face the air outlet towards the nearest available wall keeping about 50 cm distance. (Fig. 2-2)
- ② Install an optional air guide if the unit is installed in a location where strong winds such as a typhoon, etc. may directly blow to the air outlet. (Fig. 2-3)
 - Ⓐ Air outlet guide
- ③ Position the unit so that the outlet air can blow at right angle to the seasonal wind direction, if possible. (Fig. 2-4)
 - Ⓑ Wind direction

2.4. NECESSARY SPACE TO INSTALL

2.4.1. When installing a single outdoor unit (Refer to the last page)

Minimum dimensions are as follows, unless Maximum dimensions are indicated.

Refer to the figures for each case.

- ① Obstacles at rear only (Fig. 2-5)
- ② Obstacles at rear and above only (Fig. 2-6)
- ③ Obstacles at rear and side(s) only (Fig. 2-7)
- ④ Obstacles at front only (Fig. 2-8)
- ⑤ Obstacles at front and rear only (Fig. 2-9)
- ⑥ Obstacles at rear, side(s), and above only (Fig. 2-10)
 - Do not install the optional air outlet guide to make upward airflow.

2.4.2. When installing multiple outdoor units (Refer to the last page)

Leave 10 mm or more between the units.

- ① Obstacles at rear only (Fig. 2-11)
- ② Obstacles at rear and above only (Fig. 2-12)
 - No more than three units must be installed side by side. Make sure to leave space as shown.
 - Do not install the optional air outlet guide to make upward airflow.
- ③ Obstacles at front only (Fig. 2-13)
- ④ Obstacles at front and rear only (Fig. 2-14)
- ⑤ When multiple units are installed in a row (Fig. 2-15)
- ⑥ When multiple units are installed in rows parallel (Fig. 2-16)
 - * When using an optional air outlet guide installed to make upward airflow, the necessary distance is 1000 mm or more.
- ⑦ To stack the unit vertically (Fig. 2-17)
 - The units can be stacked up to two units high.
 - No more than two stacked units must be installed side by side. Make sure to leave space as shown.

3. Installation procedure

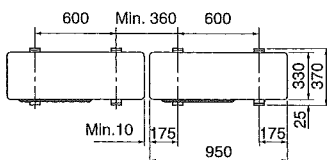
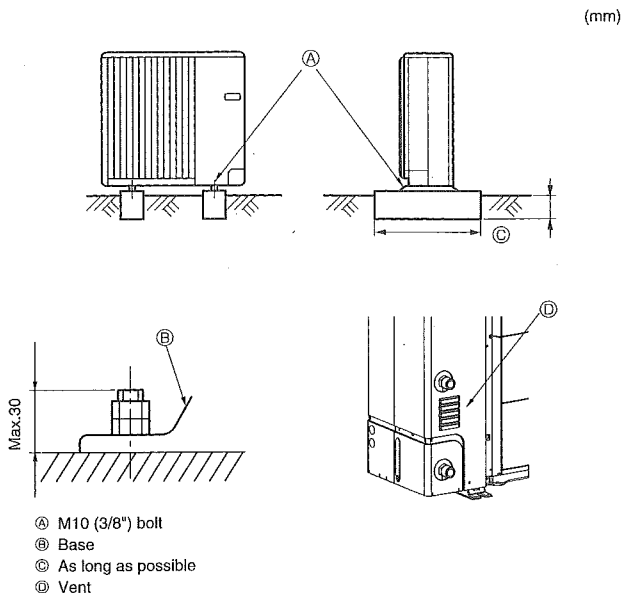

Fig. 3-1

- Be sure to install the unit in a solid, level surface to prevent rattling noises during operation. (Fig. 3-1)

<Foundation specifications>

Foundation bolt	M10 (3/8")
Thickness of concrete	120 mm
Length of bolt	70 mm
Weight-bearing capacity	320 kg

- Make sure that the length of the foundation bolt is within 30 mm from the surface of the base.
- Secure the base of the unit firmly with four-M10 foundation bolts in solid locations.

Installing the outdoor unit

- Do not block the vent. If the vent is blocked, operation will be hindered and the unit may breakdown.
- If the additional fixation of the unit is necessary, use the installation holes on the back of the unit to attach wires, etc. with self-tapping screws ($\phi 5 \times 15$ mm or less).

⚠ Warning:

- The unit must be securely installed on a structure that can sustain its weight. If the unit is mounted on an unstable structure, it may fall down and cause damage or injuries.
- The unit must be installed according to the instructions in order to minimize the risk of damage by earthquakes, typhoons, or strong winds. An improperly installed unit may fall down and cause damage or injuries.

4. Drainage piping work

Outdoor unit pipe connection

When drain piping is necessary, use the drain socket or the drain pan (option).

Optional parts name	Model name
Drain socket	PAC-SG61DS-E
Drain pan	PAC-SG64DP-E

5. Water piping work

5.1. Water piping connection (Fig.5-1)

- Connect the water pipes to the outlet and to the inlet pipes (ISO 228/1-G1B).
- Inlet and outlet pipes position is shown on the Fig.5-1.
- Install the hydraulic filter at the water intake.
- Maximum allowable torque at the water piping connection is 50 N·m.
- When tightening, use two wrenches.
- Check if water leaks after installation.
- Use the water pressure in less than 0.3MPa gauge.

5.2. Water quality condition

- The water in a system should be clean and with a pH value of 6.5-8.0.
- The followings are the maximum values;
 - Calcium : 100mg/L
 - Chlorine : 100mg/L
 - Iron/manganese : 0.5mg/L

[Fig. 5-1]

- Ⓐ Water outlet
- Ⓑ Water inlet

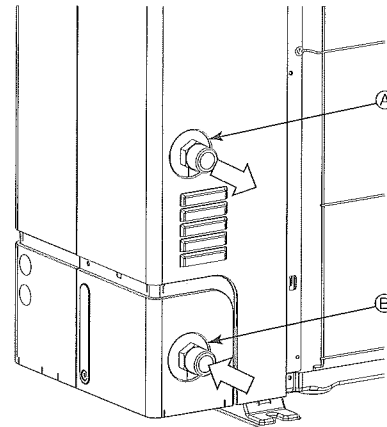

Fig. 5-1

Note : Insulate the water piping properly. The performance can be poor if the insulation is insufficient.

⚠ Warning:

As the outlet water temperature can reach 60°C at maximum, do not touch directly the water piping with a bare hand.

6. Electrical work

6.1. Outdoor unit (Fig. 6-1, Fig. 6-2)

- 1 Remove the service panel.
- 2 Wire the cables referring to the Fig. 6-1 and the Fig. 6-2.

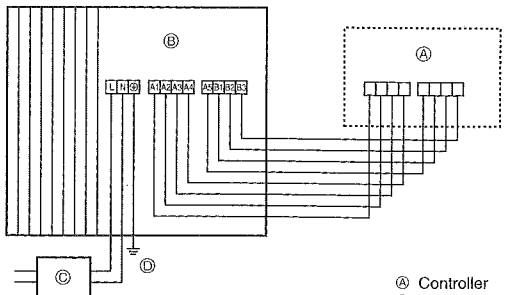

Fig. 6-1

- Ⓐ Controller
- Ⓑ Outdoor unit
- Ⓒ Breaker
- Ⓓ Earth

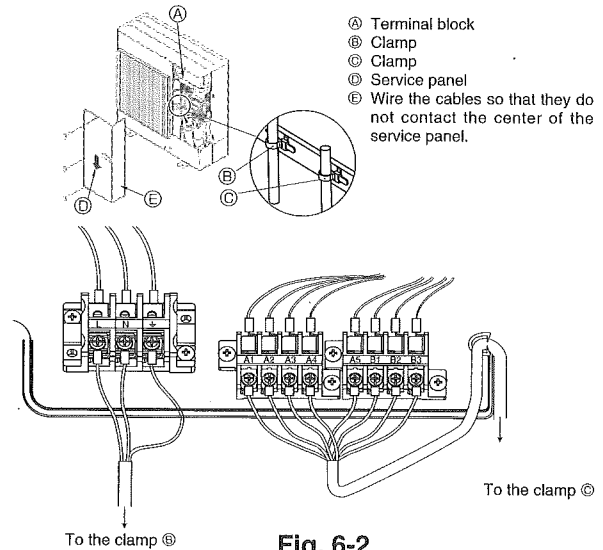

Fig. 6-2

- Ⓐ Terminal block
- Ⓑ Clamp
- Ⓒ Clamp
- Ⓓ Service panel
- Ⓔ Wire the cables so that they do not contact the center of the service panel.

6.2. Field electrical wiring

Outdoor unit power supply		~ /N (single), 50 Hz, 230 V
Outdoor unit Circuit Breaker capacity	*1	25 A
Wiring Wire No. x size (mm ²)	Outdoor unit power supply, earth	3 x Min. 4
	Controller-Outdoor unit	*2 8 x Min. 0.5 (polar)
Circuit rating	Outdoor unit L-N (single)	AC 230 V
	Controller-Outdoor unit	DC 12 V

*1. A breaker with at least 3.0 mm contact separation in each poles shall be provided. Use non-fuse breaker (NF) or earth leakage breaker (NV).

*2. Max. 20 m

Notes: 1. Wiring size must comply with the applicable local and national codes.

2. Power supply cables and the cables between Controller and Outdoor unit shall not be lighter than polychloroprene sheathed flexible cables. (Design 60245 IEC 57)

3. Be sure to connect the cables between Controller and Outdoor unit directly to the units (no intermediate connections are allowed). Intermediate connections may result in communication errors. If water enters at the intermediate connection point, it may cause insufficient insulation to ground or a poor electrical contact. (If an intermediate connection is necessary, be sure to take measures to prevent water from entering the cables.)

4. Install an earth longer than other cables.

7. Test run

Before test run

- ▶ After installation works are completed, check if there is no refrigerant leakage, no looseness in the power supply or control wiring, no wrong polarity, and no disconnection of one phase in the supply.
- ▶ Use a 500-volt megohmmeter to check that the resistance between the power supply terminals and ground is at least $1.0\text{M}\Omega$.

Warning:

Do not use the air to water heat pump if the insulation resistance is less than $1.0\text{M}\Omega$.

Insulation resistance

When installed the power source to the unit has been cut for an extended period, the insulation resistance may drop below $1\text{M}\Omega$ due to the accumulation of refrigerant within the compressor. This is not a malfunction. Perform the following procedures.

1. Remove the wires from the compressor and measure the insulation resistance of the compressor.
2. If the insulation resistance is below $1\text{M}\Omega$, the compressor may be faulty or simply the accumulation of refrigerant in the compressor makes the resistance drop.

3. After connecting the wires to the compressor, the compressor starts to warm up once power is supplied. After supplying power for the times indicated below, measure the insulation resistance again.
 - The insulation resistance drops due to the accumulation of refrigerant in the compressor. The resistance will rise above $1\text{M}\Omega$ after the compressor is warmed up for four hours.
(The necessary time to warm up the compressor varies according to atmospheric conditions and refrigerant accumulation.)
 - If the refrigerant accumulates within the compressor, the compressor must be warmed up at least 12 hours before starting the operation to prevent breakdown.
4. If the insulation resistance rises above $1\text{M}\Omega$, the compressor is not faulty.

Caution:

- The compressor does not operate if the power supply phase connection is incorrect.
- Turn on the power at least 12 hours before starting operation.
- Starting operation immediately after turning on the main power switch can result in severe damage to internal parts. Keep the power switch turned on during the operating period.

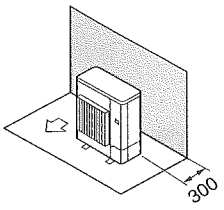

Fig. 2-5

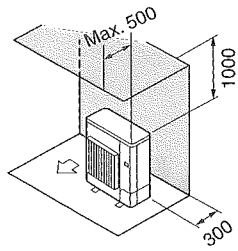

Fig. 2-6

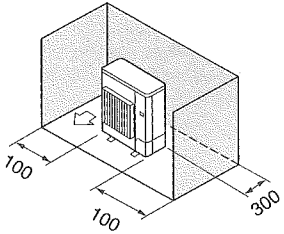

Fig. 2-7

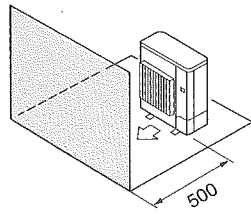

Fig. 2-8

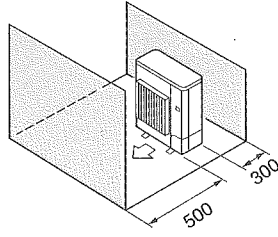

Fig. 2-9

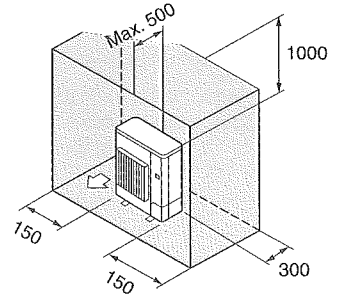

Fig. 2-10

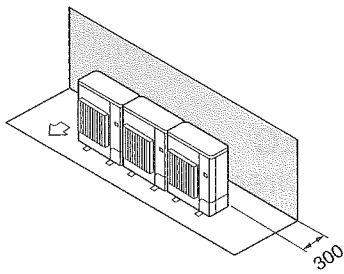

Fig. 2-11

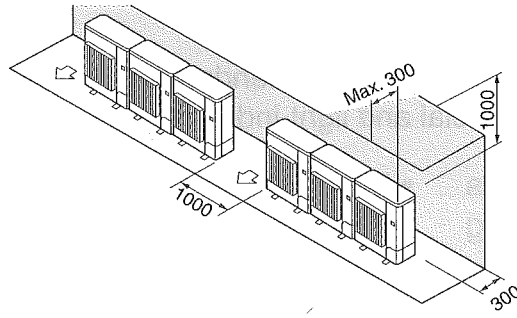

Fig. 2-12

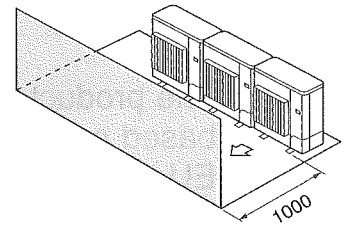

Fig. 2-13

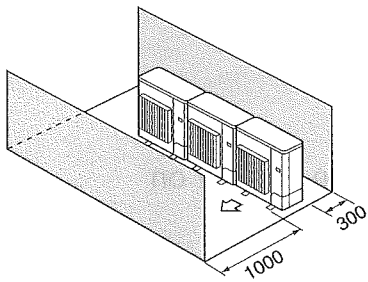

Fig. 2-14

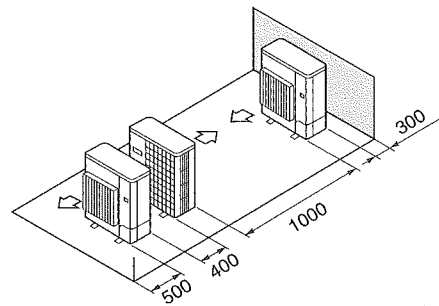

Fig. 2-15

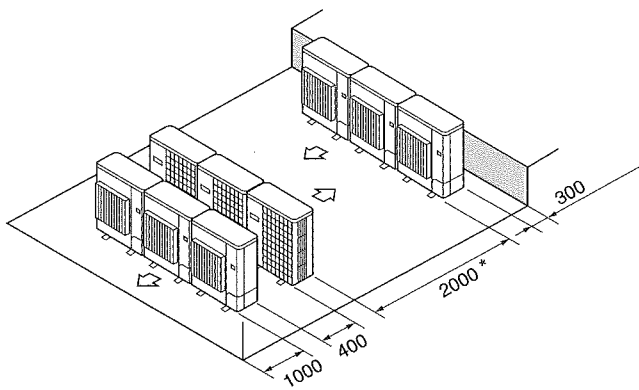

Fig. 2-16

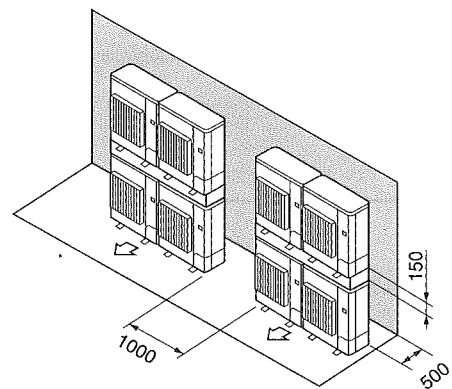

Fig. 2-17

This product is designed and intended for use in the residential,
commercial and light-industrial environment.

The product at hand is based on the following EU regulations:

- Low Voltage Directive 2006/95/ EC
- Electromagnetic Compatibility Directive 89/336/ EEC

Please be sure to put the contact address/telephone number on
this manual before handing it to the customer.

