

VAR. Č.1 - 1 / 2 PROSTORU VYVÝŠENÁ O 600 mm
+SCHODIŠTĚ DOLŮ

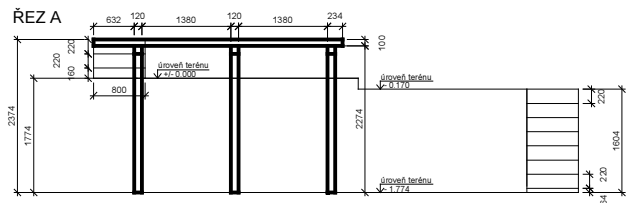

PŮDORYS

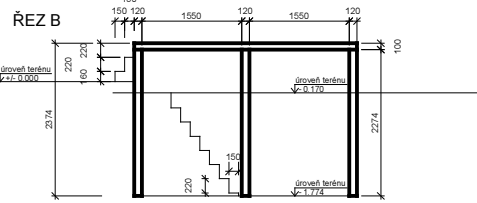
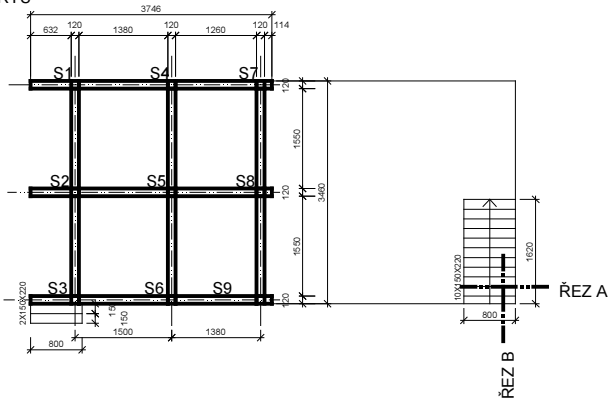

VAR. Č.2 - 2 / 3 PROSTORU VYVÝŠENO O 600 mm
+SCHODIŠTĚ DOLŮ

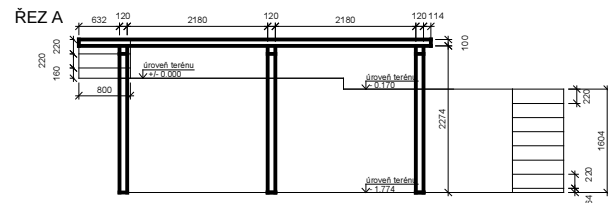

PŮDORYS

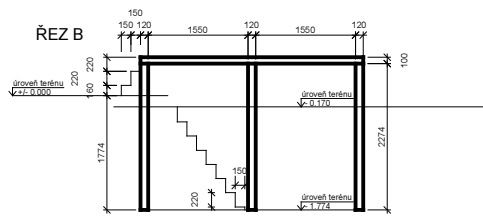
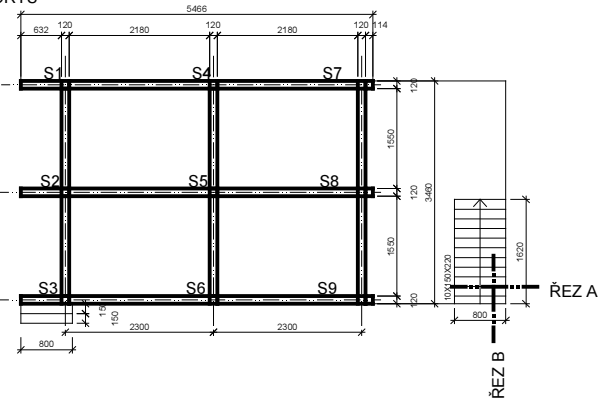

VAR. Č.3 ZAKRYTÝ CELÝ BAZÉN, V ÚROVNI TERÉNU
+SCHODIŠTĚ DOLŮ

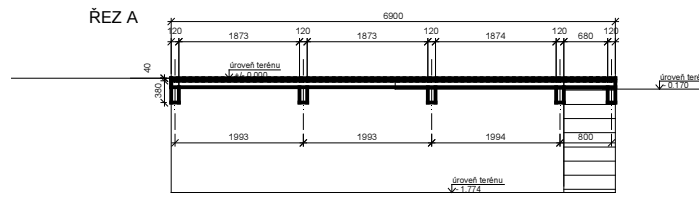

PŮDORYS

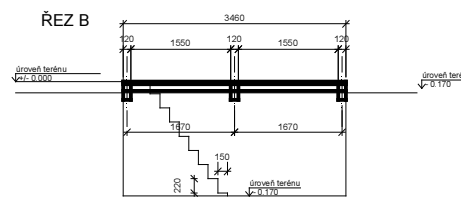
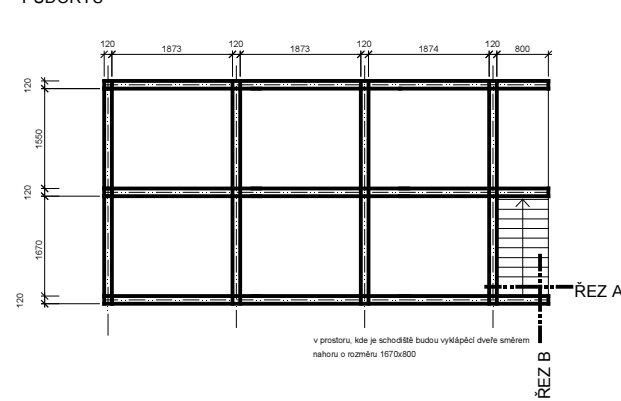

VAR. Č.4 - ZAKRYTÝ CELÝ BAZÉN, VYVÝŠENÉ PÓDIUM o 254 cm
+SCHODIŠTĚ DOLŮ

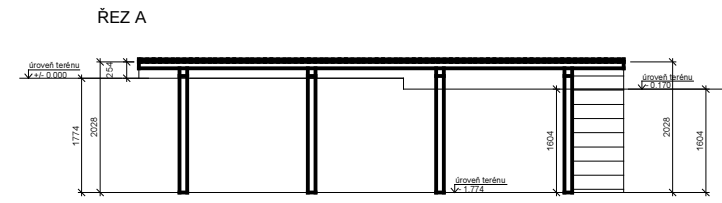

PŮDORYS

